

RS9116 n-Link™ and WiSeConnect™ Wi-Fi® and Dual-Mode Bluetooth® 5 Wireless Connectivity CC1 Module Solutions

Overview

1.1 Features

Wi-Fi

- Compliant to 1x1 IEEE 802.11 a/b/g/n with dual band (2.4 and 5 GHz) support
- Transmit power up to +18 dBm in 2.4 GHz and +13.5 dBm in 5 GHz
- Receive sensitivity as low as -96 dBm in 2.4 GHz and -89 dBm in 5 GHz
- Data Rates: 802.11b: Up to 11 Mbps; 802.11g/a: Up to 54 Mbps; 802.11n: MCS0 to MCS7
- Operating Frequency Range: 2412 MHz – 2484 MHz, 4.9 GHz – 5.975 GHz

Bluetooth

- Transmit power up to +16 dBm with integrated PA
- Receive sensitivity: LE: -92 dBm, LR 125 Kbps: -102 dBm
- Compliant to dual-mode Bluetooth 5
- <8 mA transmits current in Bluetooth 5 mode, 2 Mbps data rate
- Data rates: 125 Kbps, 500 Kbps, 1 Mbps, 2 Mbps, 3 Mbps
- Operating Frequency Range: 2.402 GHz - 2.480 GHz
- Bluetooth 2.1 + EDR, Bluetooth Low Energy 4.0 / 4.1 / 4.2 / 5.0
- Bluetooth Low Energy 1 Mbps, 2 Mbps and Long-Range modes
- Bluetooth Low Energy Secure connections
- Bluetooth Low Energy supports central role and peripheral role concurrently
- Bluetooth auto rate and auto TX power adaptation
- Scatternet* with two secondary roles while still being visible

RF Features

- Integrated baseband processor with calibration memory, RF transceiver, high-power amplifier, balun and T/R switch
- Modules with Integrated Antenna and u.FL connector



LGA Module (15 x 15.7 x 2.2) mm

- Diversity is supported

Power Consumption (2.4 GHz)

- Wi-Fi Standby Associated mode current: 102 uA @ 1 second beacon interval
- Wi-Fi 1 Mbps Listen current: 14 mA
- Wi-Fi LP chain Rx current: 20 mA
- Deep sleep current <1 uA, Standby current (RAM retention) < 10 uA

Operating Conditions

- Operating supply range: 3.0 V to 3.63 V
- Operating temperature: -40 °C to +85 °C

Size

- Small Form Factor: 15 x 15.7 x 2.2 mm

Software Operating Modes

- Hosted mode (n-Link™): Wi-Fi stack, Bluetooth stack and profiles and all network stacks reside on the host processor
- Embedded mode (WiSeConnect™): Wi-Fi stack, TCP/IP stack, IP modules, Bluetooth stack and some profiles reside in RS9116; Some of the Bluetooth profiles reside in the host processor

Hosted Mode (n-Link™)

- Available host interfaces: SDIO 2.0 and USB HS
- Support for 20 MHz channel bandwidth
- Application data throughput up to 50 Mbps (Hosted Mode) in 802.11n with 20 MHz bandwidth
- Host drivers for Linux
- Support for Client mode, Access point mode (Up to 16 clients), Concurrent Client and Access Point mode, and Enterprise Security
- Support for concurrent Wi-Fi, dual-mode Bluetooth 5

Embedded Mode (WiSeConnect™)

- Available host interface: UART, SPI, SDIO, and USB CDC
- Support for Embedded Client mode, Access Point mode (Up to 8 clients), Concurrent Client and Access Point mode, and Enterprise Security

- Supports advanced security features: WPA2/WPA3 - Personal and WPA/WPA2 – Enterprise*
- Integrated TCP/IP stack, HTTP/HTTPS, SSL/TLS, MQTT
- Bluetooth inbuilt stack support for L2CAP, RFCOMM, SDP, SPP, GAP
- Bluetooth profile support for GAP, SDP, SPP, GATT, L2CAP, RFCOMM
- Wireless firmware update and provisioning
- Support for concurrent Wi-Fi, dual-mode Bluetooth 5

Security

- Accelerators: AES128/256 in Embedded Mode
- WPA2/WPA3 - Personal and WPA/WPA2 - Enterprise for Client*

Software and Regulatory Certification

- Wi-Fi Alliance*
- Bluetooth Qualification*
- Regulatory certifications (FCC, IC, CE/ETSI, TELEC) *

Evaluation Kit

- Dual Band EVK: RS9116X-DB-EVK1

* SW features depends on the firmware version. For a detailed list of software features and available profiles, refer to the Software Reference Manuals or contact Silicon Labs for availability.

All power and performance numbers are under ideal conditions.

1.2 Applications

Wearables

Smart Watches, Wristbands, Fitness Monitors, Smart Glasses, etc.

Smart Home

Smart Locks, Motion/Entrance Sensors, Water Leak Sensors, Smart Plugs/Switches, LED Lights, Door-Bell Cameras, Washers/Dryers, Refrigerators, Thermostats, Consumer Security Cameras, Voice Assistants, etc.

Other Consumer Applications

Toys, Anti-Theft Tags, Smart Dispensers, Weighing Scales, Blood Pressure Monitors, Blood Sugar Monitors, Portable Cameras, etc.

Other Applications (Medical, Industrial, Retail, Agricultural, Smart City, etc.)

Healthcare Tags, Medical Patches/Pills, Infusion Pumps, Sensors/Actuators in Manufacturing, Electronic Shelf Labels, Agricultural Sensors, Product Tracking Tags, Smart Meters, Parking Sensors, Street LED Lighting, Automotive After-Market, Security Cameras, etc.

1.3 Description

Silicon Labs' RS9116 dual band CC1 module provides a comprehensive multi-protocol wireless connectivity solution including 802.11 a/b/g/n (2.4 GHz and 5 GHz), and dual-mode Bluetooth 5. The modules offer high throughput, extended range with power-optimized performance. The modules are FCC, IC, TELEC, and ETSI/CE (including EN 300 328 v2.2.2) certified.

1.4 Block Diagrams

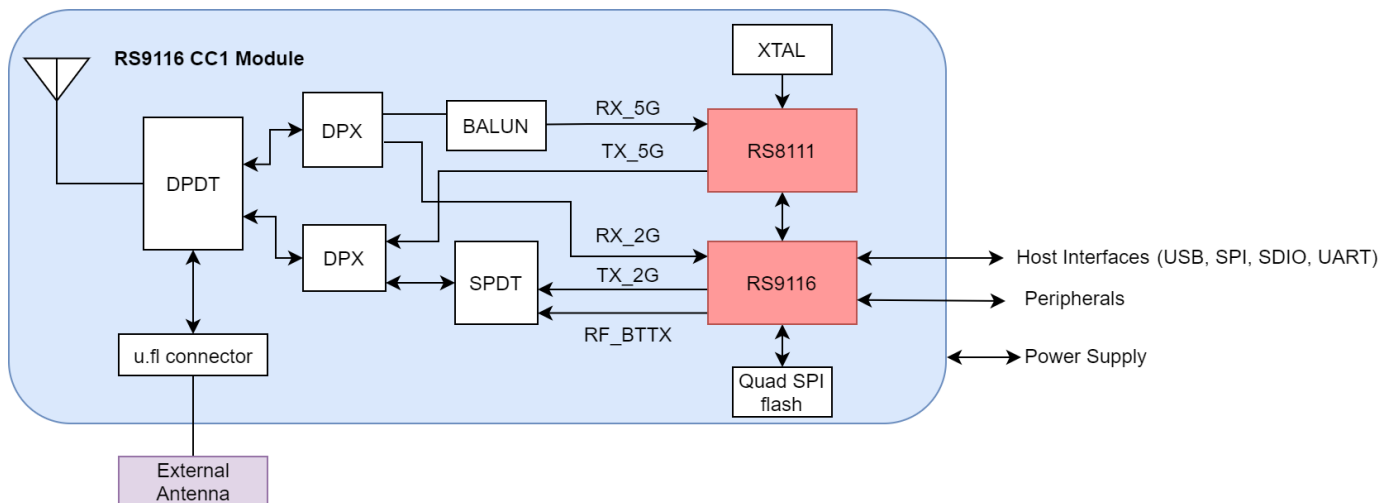

Figure 1. CC1 Module Block Diagram

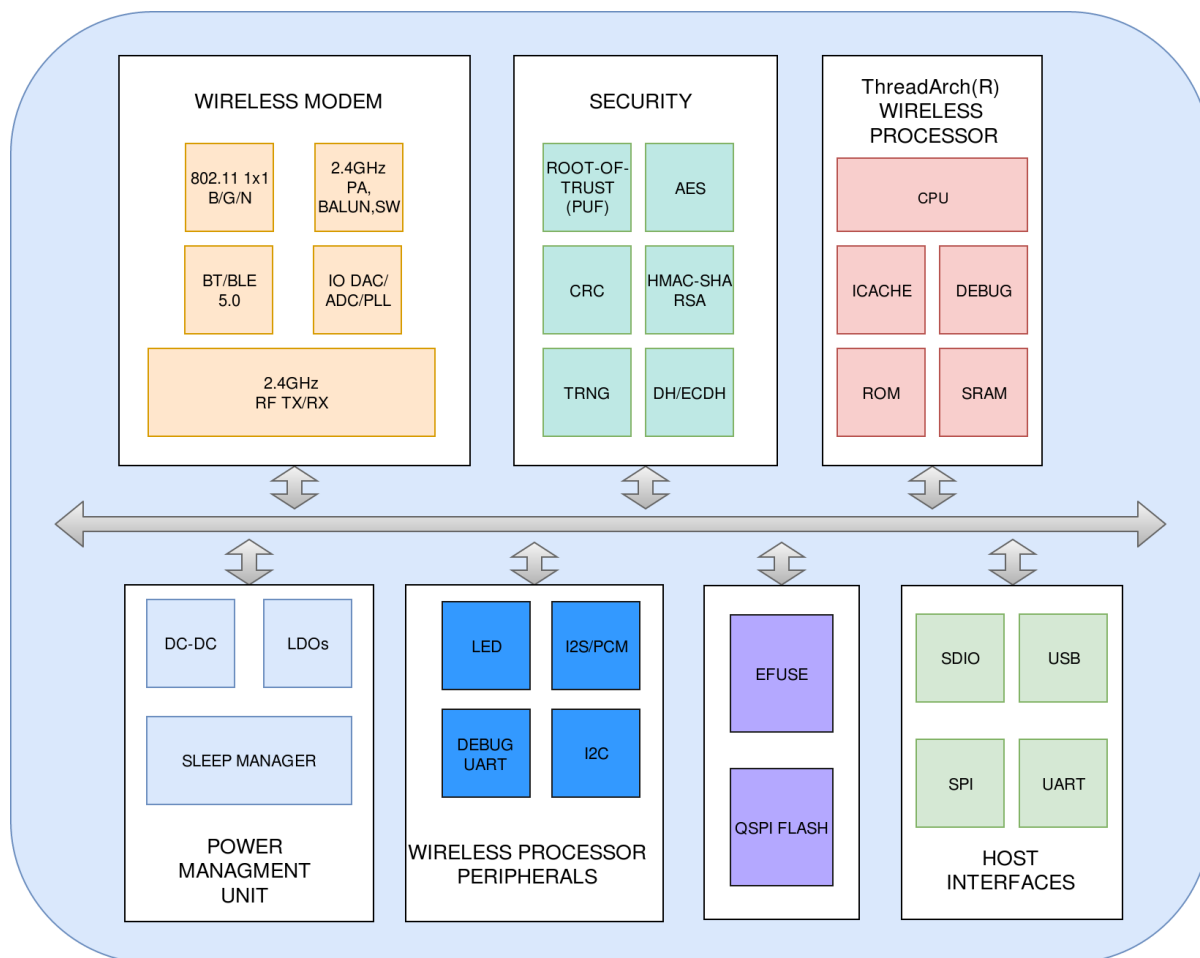

Figure 2. RS9116 Connectivity Hardware Block Diagram

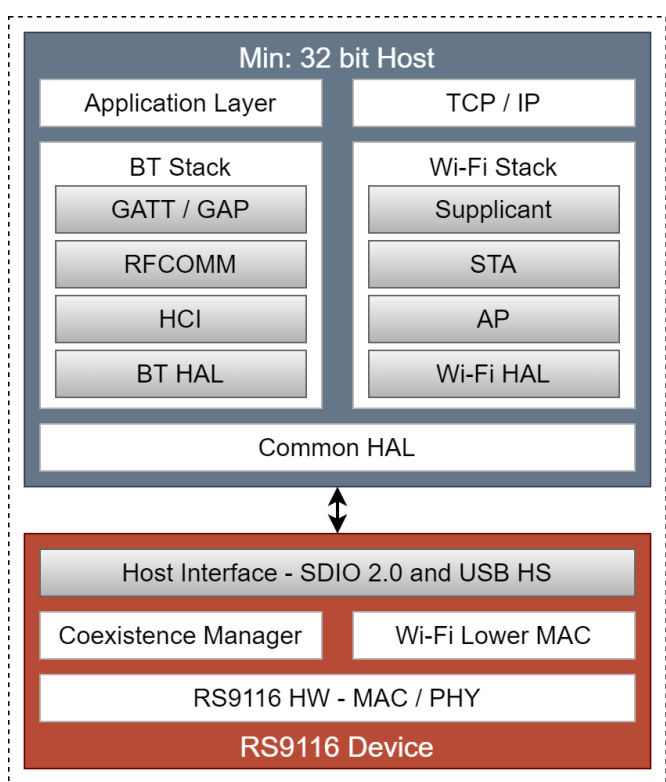

Figure 3. Hosted Software Architecture

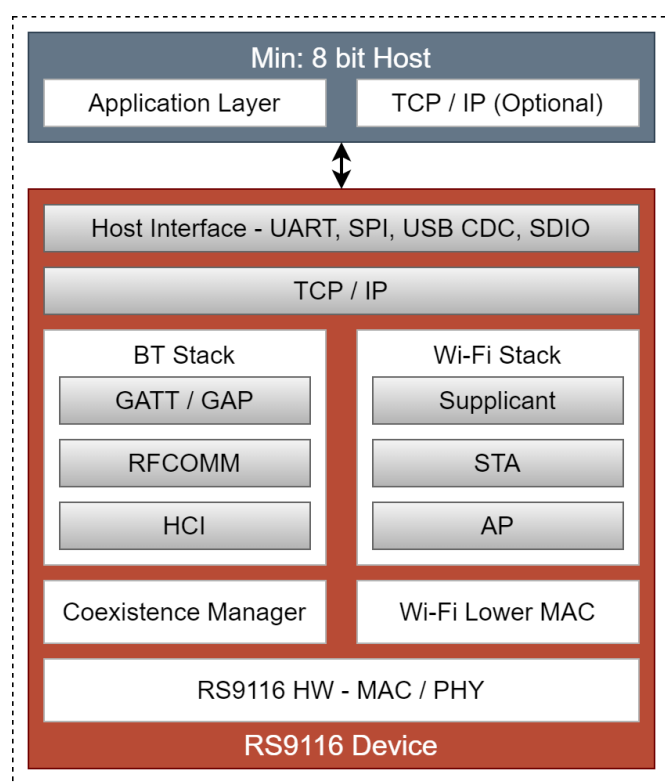

Figure 4. Embedded Software Architecture

Customer can connect multiple hosts, but only one host interface can be active after power-on.

NOTE: This content may contain offensive terminology that is now obsolete. Silicon Labs is replacing these terms with inclusive language wherever possible. For more information, visit www.silabs.com/about-us/inclusive-lexicon-project

Table of Contents

1	Overview	1
1.1	Features	1
1.2	Applications	2
1.3	Description	2
1.4	Block Diagrams	3
2	RS9116 CC1 Module Pinout and Pin Description	7
2.1	Pin Diagram	7
2.2	Pin Description	8
2.2.1	RF & Control Interfaces	8
2.2.2	Power & Ground Pins	8
2.2.3	Host & Peripheral Interfaces	10
2.2.4	Miscellaneous Pins	22
3	RS9116 CC1 Module Specifications	23
3.1	Absolute Maximum Ratings	23
3.2	Recommended Operating Conditions	23
3.3	DC Characteristics	24
3.3.1	Reset Pin	24
3.3.2	Power Sequence	25
3.3.3	Hardware Resetting Sequence after Power On	30
3.3.4	Digital Input Output Signals	31
3.3.5	USB	31
3.3.6	Pin Capacitances	31
3.4	AC Characteristics	31
3.4.1	Clock Specifications	31
3.4.2	SDIO 2.0 Secondary	33
3.4.3	SPI Secondary	34
3.4.4	USB	36
3.4.5	UART	36
3.4.6	I2C Main and Secondary	36
3.4.7	I2S/PCM Main and Secondary	37
3.4.8	GPIO pins	39
3.5	RF Characteristics	39
3.5.1	WLAN 2.4 GHz Transmitter Characteristics	39
3.5.2	WLAN 2.4 GHz Receiver Characteristics on High-Performance (HP) RF Chain	41
3.5.3	WLAN 2.4 GHz Receiver Characteristics on Low-Power (LP) RF Chain	43
3.5.4	Bluetooth Transmitter Characteristics on High-Performance (HP) RF Chain	44
3.5.5	Bluetooth Transmitter Characteristics on Low-Power (LP) 0 dBm RF Chain	46
3.5.6	Bluetooth Receiver Characteristics on High-Performance (HP) RF Chain	47
3.5.7	Bluetooth Receiver Characteristics on Low-Power (LP) RF Chain	49
3.5.8	WLAN 5GHz Transmitter Characteristics	51
3.5.9	WLAN 5GHz Receiver Characteristics	54
3.6	Typical Current Consumption	57
3.6.1	3.3 V	57
4	RS9116 CC1 Module Detailed Description	60
4.1	Overview	60
4.2	Module Features	60
4.2.1	WLAN	60
4.2.2	Bluetooth	60
4.2.3	RF Transceiver	62
4.2.4	Host Interfaces	62
4.2.5	Wireless Coexistence Manager	62
4.2.6	Software	63
4.2.7	Security	63
4.2.8	Power Management	64
4.2.9	Low Power Modes	64
4.2.10	Memory	65
5	RS9116 CC1 Module Reference Schematics, BOM and Layout Guidelines	66
5.1	SDIO/SPI/UART	66
5.1.1	Schematics	66
5.1.2	Bill of Materials	68
5.2	USB/USB-CDC	69
5.2.1	Schematics	69
5.2.2	Bill of Materials	71
5.3	Layout Guidelines	72
6	RS9116 CC1 Module Antenna Specifications	76

6.1	Overview.....	76
6.2	PCB Antenna Performance Specifications.....	76
6.2.1	Return Loss Characteristic of the Antenna.....	76
6.2.2	Module Reference Orientation.....	76
6.2.3	2D Gain Plots at 2.4 GHz.....	77
6.2.4	2D Gain Plots at 2.430 GHz.....	78
6.2.5	2D Gain Plots at 2.480 GHz.....	80
6.2.6	2D Gain Plots at 5.1 GHz.....	81
6.2.7	2D Gain Plots at 5.5 GHz.....	83
6.2.8	2D Gain Plots at 5.9 GHz.....	84
6.3	Antenna Parameters.....	85
6.4	Mechanical Characteristics.....	85
7	RS9116 CC1 Module Package Description.....	86
7.1	Dimensions.....	86
7.1.1	Packing Information of Modules with Package Codes CC1.....	86
7.2	Package Outline.....	87
7.3	PCB Landing Pattern.....	88
8	RS9116 CC1 Module Certification and Ordering Information.....	89
8.1	Certification Information.....	89
8.2	Compliance and Certification.....	89
8.2.1	Federal Communication Commission Statement.....	89
8.2.2	Industry Canada / ISED Statement.....	90
8.2.3	CE.....	91
8.2.4	TELEC.....	91
8.2.5	Qualified Antenna Types.....	91
8.2.6	Module Marking Information.....	92
8.3	Module Package.....	93
8.4	Ordering Information.....	93
9	RS9116 CC1 Module Documentation and Support.....	94
9.1	Resource Location.....	94
10	RS9116 CC1 Module Revision History.....	95

2 RS9116 CC1 Module Pinout and Pin Description

2.1 Pin Diagram



Figure 5. RS9116 CC1 Pin Diagram

2.2 Pin Description

2.2.1 RF & Control Interfaces

Pin Name	Pin Number	I/O Supply Domain	Direction	Initial State (Power up, Active Reset)	Description
RESET_N	33	UULP_VBATT_1	Input	NA	Active-low reset asynchronous reset signal
POC_IN	30	UULP_VBATT_1	Input	NA	Power On Control Input This is an input to the chip. It should be made high only after supplies are valid to ensure the IC is in safe state until valid power supply is available.
POC_OUT	84	UULP_VBATT_1	Output	NA	Power On Control Output This is internally generated. Initially, it is low. But it becomes high when the supplies (VBATT, UULP_VOUTSCDC) are valid.

Table 1. RF & Control Interfaces

2.2.2 Power & Ground Pins

Pin Name	Type	Pin Number	Direction	Description
UULP_VBATT_1	Power	67	Input	Always-on VBATT Power supply to the UULP domains
VIN_3P3	Power	71	Input	Digital Power Supply
VOUTLDOSOC	Power	16	Output	Output of SoC LDO
VOUTLDO1P8	Power	108	Output	Output of 1.8V LDO
VOUTLDOAFE	Power	98	Output	Output of AFE LDO
SDIO_IO_VDD	Power	8	Input	I/O Supply for SDIO I/Os. Refer to the GPIOs section for details on which GPIOs have this as the I/O supply.
ULP_IO_VDD	Power	116	Input	I/O Supply for ULP GPIOs
PA5G_AVDD	Power	47	Input	Power supply for the 5 GHz RF Power Amplifier

Pin Name	Type	Pin Number	Direction	Description
RF_AVDD_BTTX	Power	48	Input	Power supply for Bluetooth Transmit circuit. Connect to VOUTLDOAFE as per the Reference Schematics.
RF_AVDD33	Power	86	Input	Power supply for the 5 GHz RF
AVDD_1P9_3P3	Power	45	Input	Power supply for the 5 GHz RF
AVDD_1P2	Power	85	Input	Power supply for the 5 GHz RF. Connect to VOUTLDOSOC as per the Reference Schematics.
UULP_VOUTSCDC	Power	79	Output	UULP Switched Cap DCDC Output
UULP_VOUTSCDC_RETN	Power	77	Output	UULP Retention Supply Output
UULP_AVDD	Power	109	Input	Power supply for the always-on digital and ULP peripherals. Connect to UULP_VOUTSCDC as per the Reference Schematics.
USB_AVDD_3P3	Power	66	Input	Power Supply for the USB interface
USB_AVDD_1P1	Power	11	Input	Power supply for the USB core
GND	Ground	1, 12, 13, 14, 15, 17, 19, 34, 35, 36, 41, 49, 50, 51, 52, 53, 54, 55, 56, 57, 68, 69, 70, 72, 73, 74, 87, 88, 89, 93, 97, 99, 100, 101, 102, 103, 104, 105, 106, 107, 112, 113, 114, 115, 120, 121, 122, 123, 127, 128, 129, 130, 131, 136, 137, 138, 139, 144, 145, 146, 147, 153, 154, 155	GND	Common ground pins

Table 2. Power and Ground Pins

2.2.3 Host & Peripheral Interfaces

Pin Name	Pin Number	I/O Supply Domain	Direction	Initial State (Power up, Active Reset)	Description ^{1,2,3,4}									
GPIO_6	150	VIN_3P3	Inout	HighZ	<p>Default: HighZ</p> <p>Sleep: HighZ</p> <p>This pin can be configured by software to be any of the following</p> <ul style="list-style-type: none"> I2S_DOUT - I2S interface output data. PCM_DOUT - PCM interface output data. 									
GPIO_7	119	VIN_3P3	Inout	HighZ	<p>Default: HighZ</p> <p>Sleep: HighZ</p> <p>This pin can be configured by software to be any of the following</p> <ul style="list-style-type: none"> I2S_CLK - I2S interface clock. PCM_CLK - PCM interface clock. 									
GPIO_8/UART1_RX	135	VIN_3P3	Inout	HighZ	<table border="1"> <thead> <tr> <th>Host</th> <th>Default</th> <th>Sleep</th> </tr> </thead> <tbody> <tr> <td>UART</td> <td>UART1_RX - UART Host interface serial input.</td> <td>HighZ</td> </tr> <tr> <td>Non UART</td> <td>HighZ</td> <td>HighZ</td> </tr> </tbody> </table> <p>The UART interface is supported only in WiSeConnect™.</p>	Host	Default	Sleep	UART	UART1_RX - UART Host interface serial input.	HighZ	Non UART	HighZ	HighZ
Host	Default	Sleep												
UART	UART1_RX - UART Host interface serial input.	HighZ												
Non UART	HighZ	HighZ												
GPIO_9/UART1_TX	151	VIN_3P3	Inout	HighZ	<table border="1"> <thead> <tr> <th>Host</th> <th>Default</th> <th>Sleep</th> </tr> </thead> <tbody> <tr> <td>UART</td> <td>UART1_TX - UART Host interface serial output.</td> <td>HighZ</td> </tr> <tr> <td>Non UART</td> <td>HighZ</td> <td>HighZ</td> </tr> </tbody> </table>	Host	Default	Sleep	UART	UART1_TX - UART Host interface serial output.	HighZ	Non UART	HighZ	HighZ
Host	Default	Sleep												
UART	UART1_TX - UART Host interface serial output.	HighZ												
Non UART	HighZ	HighZ												

Pin Name	Pin Number	I/O Supply Domain	Direction	Initial State (Power up, Active Reset)	Description ^{1,2,3,4}
					The UART interface is supported only in WiSeConnect™.
GPIO_10	142	VIN_3P3	Inout	HighZ	Default: HighZ Sleep: HighZ This pin can be configured by software to be any of the following <ul style="list-style-type: none"> I2S_DIN: I2S interface input data. PCM_DIN - PCM interface input data.
GPIO_11	149	VIN_3P3	Inout	HighZ	Default: HighZ. Sleep: HighZ This pin can be configured by software to be any of the following <ul style="list-style-type: none"> I2S_WS: I2S interface Word Select. PCM_FSYNC: PCM interface Frame Synchronization signal.
GPIO_12	143	VIN_3P3	Inout	HighZ	Default: HighZ Sleep: HighZ This pin can be configured by software to be any of the following <ul style="list-style-type: none"> UART1_RTS - UART interface Request to Send, if UART Host Interface flow control is enabled. The UART interface is supported only in WiSeConnect™.
GPIO_15	61	VIN_3P3	Inout	HighZ	Default: HighZ Sleep: HighZ This pin can be configured by software to be any of the following

Pin Name	Pin Number	I/O Supply Domain	Direction	Initial State (Power up, Active Reset)	Description ^{1,2,3,4}												
					<ul style="list-style-type: none"> UART1_CTS - UART interface Clear to Send, if UART Host Interface flow control is enabled. UART1_TRANSPARENT_MODE - UART Host interface Transparent Mode, Indication that module has entered into TRANSPERENT_MODE TSF_SYNC - Transmit Synchronization Function signal to indicate to the Host when a packet is transmitted. The signal is toggled once at the end of every transmitted packet. <p>The UART interface is supported only in WiSeConnect™.</p>												
SDIO_CLK/SPI_CLK	5	SDIO_IO_VDD	Inout	HighZ	<table border="1"> <thead> <tr> <th>Host</th> <th>Default</th> <th>Sleep</th> </tr> </thead> <tbody> <tr> <td>SDIO</td> <td>SDIO_CLK - SDIO interface clock</td> <td>HighZ</td> </tr> <tr> <td>SPI</td> <td>SPI_CLK - SPI Secondary interface clock</td> <td>HighZ</td> </tr> <tr> <td>Non SDIO, SPI</td> <td>HighZ</td> <td>HighZ</td> </tr> </tbody> </table> <p>The SPI interface is supported only in WiSeConnect™.</p>	Host	Default	Sleep	SDIO	SDIO_CLK - SDIO interface clock	HighZ	SPI	SPI_CLK - SPI Secondary interface clock	HighZ	Non SDIO, SPI	HighZ	HighZ
Host	Default	Sleep															
SDIO	SDIO_CLK - SDIO interface clock	HighZ															
SPI	SPI_CLK - SPI Secondary interface clock	HighZ															
Non SDIO, SPI	HighZ	HighZ															
SDIO_CMD/SPI_CSN	62	SDIO_IO_VDD	Inout	HighZ	<table border="1"> <thead> <tr> <th>Host</th> <th>Default</th> <th>Sleep</th> </tr> </thead> <tbody> <tr> <td>SDIO</td> <td>SDIO_CMD - SDIO</td> <td>HighZ</td> </tr> </tbody> </table>	Host	Default	Sleep	SDIO	SDIO_CMD - SDIO	HighZ						
Host	Default	Sleep															
SDIO	SDIO_CMD - SDIO	HighZ															

Pin Name	Pin Number	I/O Supply Domain	Direction	Initial State (Power up, Active Reset)	Description ^{1,2,3,4}												
					<table border="1"> <tr> <td></td> <td>interface CMD signal</td> <td></td> </tr> <tr> <td>SPI</td> <td>SPI_CSN - Active-low Chip Select signal of SPI Secondary interface</td> <td>HighZ</td> </tr> <tr> <td>Non SDIO, SPI</td> <td>HighZ</td> <td>HighZ</td> </tr> </table> <p>The SPI interface is supported only in WiSeConnect™.</p>		interface CMD signal		SPI	SPI_CSN - Active-low Chip Select signal of SPI Secondary interface	HighZ	Non SDIO, SPI	HighZ	HighZ			
	interface CMD signal																
SPI	SPI_CSN - Active-low Chip Select signal of SPI Secondary interface	HighZ															
Non SDIO, SPI	HighZ	HighZ															
SDIO_D0/SPI_MOSI	6	SDIO_IO_VDD	Inout	HighZ	<table border="1"> <thead> <tr> <th>Host</th> <th>Default</th> <th>Sleep</th> </tr> </thead> <tbody> <tr> <td>SDIO</td> <td>SDIO_D0 - SDIO interface Data0 signal</td> <td>HighZ</td> </tr> <tr> <td>SPI</td> <td>SPI_MOSI - SPI Secondary interface Main-Out- Secondary- In signal</td> <td>HighZ</td> </tr> <tr> <td>Non SDIO, SPI</td> <td>HighZ</td> <td>HighZ</td> </tr> </tbody> </table> <p>The SPI interface is supported only in WiSeConnect™.</p>	Host	Default	Sleep	SDIO	SDIO_D0 - SDIO interface Data0 signal	HighZ	SPI	SPI_MOSI - SPI Secondary interface Main-Out- Secondary- In signal	HighZ	Non SDIO, SPI	HighZ	HighZ
Host	Default	Sleep															
SDIO	SDIO_D0 - SDIO interface Data0 signal	HighZ															
SPI	SPI_MOSI - SPI Secondary interface Main-Out- Secondary- In signal	HighZ															
Non SDIO, SPI	HighZ	HighZ															
SDIO_D1/SPI_MISO	63	SDIO_IO_VDD	Inout	HighZ	<table border="1"> <thead> <tr> <th>Host</th> <th>Default</th> <th>Sleep</th> </tr> </thead> <tbody> <tr> <td>SDIO</td> <td>SDIO_D1 - SDIO interface Data1 signal</td> <td>HighZ</td> </tr> </tbody> </table>	Host	Default	Sleep	SDIO	SDIO_D1 - SDIO interface Data1 signal	HighZ						
Host	Default	Sleep															
SDIO	SDIO_D1 - SDIO interface Data1 signal	HighZ															

Pin Name	Pin Number	I/O Supply Domain	Direction	Initial State (Power up, Active Reset)	Description ^{1,2,3,4}												
					<table border="1"> <tr> <td>SPI</td> <td>SPI_MISO - SPI Secondary interface Main-In-Secondary-Out signal</td> <td>HighZ</td> </tr> <tr> <td>Non SDIO, SPI</td> <td>HighZ</td> <td>HighZ</td> </tr> </table> <p>The SPI interface is supported only in WiSeConnect™.</p>	SPI	SPI_MISO - SPI Secondary interface Main-In-Secondary-Out signal	HighZ	Non SDIO, SPI	HighZ	HighZ						
SPI	SPI_MISO - SPI Secondary interface Main-In-Secondary-Out signal	HighZ															
Non SDIO, SPI	HighZ	HighZ															
SDIO_D2/SPI_INTR	7	SDIO_IO_VDD	Inout	HighZ	<table border="1"> <thead> <tr> <th>Host</th> <th>Default</th> <th>Sleep</th> </tr> </thead> <tbody> <tr> <td>SDIO</td> <td>SDIO_D2 - SDIO interface Data2 signal</td> <td>HighZ</td> </tr> <tr> <td>SPI</td> <td>SPI_INTR - SPI Secondary interface Interrupt Signal to the Host</td> <td>HighZ</td> </tr> <tr> <td>Non SDIO, SPI</td> <td>HighZ</td> <td>HighZ</td> </tr> </tbody> </table> <p>The SPI interface is supported only in WiSeConnect™.</p>	Host	Default	Sleep	SDIO	SDIO_D2 - SDIO interface Data2 signal	HighZ	SPI	SPI_INTR - SPI Secondary interface Interrupt Signal to the Host	HighZ	Non SDIO, SPI	HighZ	HighZ
Host	Default	Sleep															
SDIO	SDIO_D2 - SDIO interface Data2 signal	HighZ															
SPI	SPI_INTR - SPI Secondary interface Interrupt Signal to the Host	HighZ															
Non SDIO, SPI	HighZ	HighZ															
SDIO_D3/SPI_ERR_INTERRUPT/USB_CDC_DIS	64	SDIO_IO_VDD	Inout	Pullup	<table border="1"> <thead> <tr> <th>Host</th> <th>Default</th> <th>Sleep</th> </tr> </thead> <tbody> <tr> <td>SDIO</td> <td>SDIO_D3 - SDIO interface Data3 signal</td> <td>HighZ</td> </tr> </tbody> </table>	Host	Default	Sleep	SDIO	SDIO_D3 - SDIO interface Data3 signal	HighZ						
Host	Default	Sleep															
SDIO	SDIO_D3 - SDIO interface Data3 signal	HighZ															

Pin Name	Pin Number	I/O Supply Domain	Direction	Initial State (Power up, Active Reset)	Description ^{1,2,3,4}									
					<table border="1"> <tr> <td>SPI</td> <td>SPI_ERR_I NTR - SPI Bus Error Interrupt Signals</td> <td>HighZ</td> </tr> <tr> <td>USB</td> <td>USB_CDC_ DIS - USB- CDC Active- High Disable Signal</td> <td>HighZ</td> </tr> <tr> <td>Non SDIO, SPI</td> <td>HighZ</td> <td>HighZ</td> </tr> </table> <p>The SPI interface is supported only in WiSeConnect™.</p>	SPI	SPI_ERR_I NTR - SPI Bus Error Interrupt Signals	HighZ	USB	USB_CDC_ DIS - USB- CDC Active- High Disable Signal	HighZ	Non SDIO, SPI	HighZ	HighZ
SPI	SPI_ERR_I NTR - SPI Bus Error Interrupt Signals	HighZ												
USB	USB_CDC_ DIS - USB- CDC Active- High Disable Signal	HighZ												
Non SDIO, SPI	HighZ	HighZ												
GPIO_38	118	VIN_3P3	Inout	HighZ	Default: HighZ Sleep: HighZ									
GPIO_46	59	VIN_3P3	Inout	HighZ	Default: HighZ Sleep: HighZ									
GPIO_47	4	VIN_3P3	Inout	HighZ	Default: HighZ Sleep: HighZ									
GPIO_48	60	VIN_3P3	Inout	HighZ	Default: HighZ Sleep: HighZ									
GPIO_49	3	VIN_3P3	Inout	HighZ	Default: HighZ Sleep: HighZ									
GPIO_50	58	VIN_3P3	Inout	HighZ	Default: HighZ Sleep: HighZ									
GPIO_51	2	VIN_3P3	Inout	HighZ	Default: HighZ Sleep: HighZ									
GPIO_52	141	VIN_3P3	Inout	HighZ	Default: HighZ									

Pin Name	Pin Number	I/O Supply Domain	Direction	Initial State (Power up, Active Reset)	Description ^{1,2,3,4}
					Sleep: HighZ
GPIO_53	134	VIN_3P3	Inout	HighZ	Default: HighZ Sleep: HighZ
GPIO_54	140	VIN_3P3	Inout	HighZ	Default: HighZ Sleep: HighZ
GPIO_55	133	VIN_3P3	Inout	HighZ	Default: HighZ Sleep: HighZ
GPIO_56	132	VIN_3P3	Inout	HighZ	Default: HighZ Sleep: HighZ
GPIO_57	124	VIN_3P3	Inout	HighZ	Default: HighZ Sleep: HighZ
ULP_GPIO_0	25	ULP_IO_VDD	Inout	HighZ	Default: HighZ Sleep: HighZ This pin can be configured by software to be any of the following <ul style="list-style-type: none"> WLAN_ACTIVE*: Active-High signal to indicate to an external Bluetooth IC that WLAN transmission is active. Part of the 3-wire coexistence interface. *This pin is intended to act as WLAN_ACTIVE for wireless coexistence. Please contact Silicon Labs to learn about availability of this feature.
ULP_GPIO_1	76	ULP_IO_VDD	Inout	HighZ	Default: HighZ Sleep: HighZ This pin can be configured by software to be any of the following <ul style="list-style-type: none"> BT_ACTIVE*: Active-High signal from an external Bluetooth IC that it is

Pin Name	Pin Number	I/O Supply Domain	Direction	Initial State (Power up, Active Reset)	Description ^{1,2,3,4}
					<p>transmitting. Part of the 3-wire coexistence interface.</p> <p>*This pin is intended to act as BT_ACTIVE for Bluetooth coexistence. Please contact Silicon Labs to learn about availability of this feature.</p>
ULP_GPIO_4	26	ULP_IO_VDD	Inout	HighZ	Default: HighZ
ULP_GPIO_5	90	ULP_IO_VDD	Inout	HighZ	<p>Default: LP_WAKEUP_IN This is LP Powersave Wakeup indication from Device</p> <p>Sleep: HighZ</p> <p>This pin can be configured by software to be any of the following</p> <ul style="list-style-type: none"> • LP_WAKEUP_IN: This is LP Powersave Wakeup indication to Device from HOST • HOST_WAKEUP_INDICATION: This is used as indication from Host to dev that host is ready to take the packet and Device can transfer the packet to host. This is supported only in UART host mode. The UART interface is supported only in WiSeConnect™.
ULP_GPIO_6	20	ULP_IO_VDD	Inout	HighZ	<p>Default: HighZ</p> <p>Sleep: HighZ</p> <p>This pin can be configured by software to be any of the following</p> <ul style="list-style-type: none"> • WAKEUP_FROM_Dev* - Used as a wakeup indication to host from device • BT_PRIORITY**: Active-high signal from an external Bluetooth IC that indicates that the Bluetooth transmissions are a higher priority.

Pin Name	Pin Number	I/O Supply Domain	Direction	Initial State (Power up, Active Reset)	Description ^{1,2,3,4}
					<p>*For Wake-on-Wireless feature, it is recommended to use an external weak pull-down or pull-up resistor. It is recommended to use weak pull-down resistor in new designs. Software has to be configured suitably for using either pull-down or pull-up resistor.</p> <p>**This pin is intended to act as BT_PRIORITY for Bluetooth coexistence. Please contact Silicon Labs to learn about availability of this feature.</p>
ULP_GPIO_7	24	ULP_IO_VDD	Inout	HighZ	Default: HighZ
ULP_GPIO_8	80	ULP_IO_VDD	Inout	HighZ	<p>Default: HighZ</p> <p>Sleep: HighZ</p> <p>This pin can be configured by software to be any of the following</p> <ul style="list-style-type: none"> • LED0: Control signal to an external LED. • (* LED0 functionality currently not available in both, WiSeConnect™ and n-Link® modules)
ULP_GPIO_9/ UART2_TX	91	ULP_IO_VDD	Inout	HighZ	<p>Default: UART2_TX- Debug UART Interface serial output</p> <p>Sleep: HighZ</p> <p>UART2_TX: Debug UART interface serial output.</p>
ULP_GPIO_10	42	ULP_IO_VDD	Inout	HighZ	<p>Default: HighZ</p> <p>Sleep: HighZ</p> <p>This pin can be configured by software to be any of the following</p> <ul style="list-style-type: none"> • I2C_SCL: I2C interface clock.
ULP_GPIO_11	31	ULP_IO_VDD	Inout	HighZ	Default: HighZ

Pin Name	Pin Number	I/O Supply Domain	Direction	Initial State (Power up, Active Reset)	Description ^{1,2,3,4}
					Sleep: HighZ This pin can be configured by software to be any of the following <ul style="list-style-type: none"> I2C_SDA: I2C interface data.
UULP_VBAT_GPIO_0	83	UULP_VBATT_1	Output	High	Default: EXT_PG_EN Sleep: SLEEP_IND_FROM_DEV / EXT_PG_EN This pin can be configured by software to be any of the following <ul style="list-style-type: none"> SLEEP_IND_FROM_DEV: This signal is used to send an indication to the Host processor. An indication is sent when the chip enters (logic low) and exits (logic high) the ULP Sleep mode. EXT_PG_EN: Active-high enable signal to an external power gate which can be used to control the power supplies other than Always-ON VBATT Power Supplies in ULP Sleep mode.
UULP_VBAT_GPIO_2/ HOST_BYP_ULP_WAKEUP	92	UULP_VBATT_1	Input	HighZ	Default: HOST_BYP Sleep: ULP_WAKEUP This signal has two functionalities – one during the boot loading process and one after the boot loading. During boot loading, this signal is an active-high input to indicate that the bootloader should bypass any inputs from the Host processor and continue to load the default firmware from Flash. After boot loading, this signal is an active-high input to indicate that the module should wakeup from its Ultra Low Power (ULP) sleep mode. The bootloader bypass functionality is supported only in WiSeConnect™.

Pin Name	Pin Number	I/O Supply Domain	Direction	Initial State (Power up, Active Reset)	Description ^{1,2,3,4}
UULP_VBAT_GPIO_3	43	UULP_VBATT_1	Inout	HighZ	<p>Default: HighZ</p> <p>Sleep: XTAL_32KHZ_IN / SLEEP_IND_FROM_DEV</p> <p>This pin can be configured by software to be any of the following</p> <ul style="list-style-type: none"> • XTAL_32KHZ_IN: This pin can be used to feed external clock from a host processor or from external crystal oscillator. • SLEEP_IND_FROM_DEV: This signal is used to send an indication to the Host processor. An indication is sent when the chip enters (logic low) and exits (logic high) the ULP Sleep mode.
UULP_VBAT_GPIO_4	152	UULP_VBATT_1	Inout	HighZ	<p>Default: HighZ</p> <p>Sleep: HighZ</p> <p>This pin can be configured by software to be any of the following</p> <ul style="list-style-type: none"> • XTAL_32KHZ_IN: This pin can be used to feed external clock from a host processor or from external crystal oscillator.
JP0	29	VIN_3P3	Input	Pullup	<p>Default: JP0</p> <p>Sleep: HighZ</p> <p>JP0 - Reserved. Connect to a test point for debug purposes.</p>
JP1	111	VIN_3P3	Input	Pullup	<p>Default: JP1</p> <p>Sleep: HighZ</p> <p>JP1 - Reserved. Connect to a test point for debug purposes.</p>
JP2	82	VIN_3P3	Input	Pullup	<p>Default: JP2</p>

Pin Name	Pin Number	I/O Supply Domain	Direction	Initial State (Power up, Active Reset)	Description ^{1,2,3,4}
					Sleep: HighZ JP2 - Reserved. Connect to a test point for debug purposes.
JNC	110	VIN_3P3	NC	Pullup	Default: JNC Sleep: HighZ JNC - Reserved. Connect to a test point for debug purposes.
USB_DP	9	USB_AVDD_3P3	Inout	NA	Positive data channel from the USB connector.
USB_DM	65	USB_AVDD_3P3	Inout	NA	Negative data channel from the USB connector.
USB_ID	126	USB_AVDD_3P3	Input	NA	ID signal from the USB connector. If USB_ID pin is not connected to the host, then use a weak-pull down resistor on this pin.
USB_VBUS	10	USB_AVDD_3P3	Input	NA	5V USB VBUS signal from the USB connector. This pin is used just for detecting USB.

Table 3. Host and Peripheral Interfaces

1. **"Default"** state refers to the state of the device after initial boot loading and firmware loading is complete.
2. **"Sleep"** state refers to the state of the device after entering Sleep state which is indicated by Active-Low "SLEEP_IND_FROM_DEV" signal.
3. Please refer to **"RS9116N Open-Source Driver Technical Reference Manual"** for software programming information in hosted mode.
4. Please refer to **"RS9116W SAPI Programming Reference Manual"** for software programming information in embedded mode.
5. There are some functionalities, such as SLEEP_IND_FROM_DEV, that are available on multiple pins. However, these pins have other multiplexed functionalities. Any pin can be used based on the required functionality. Customer must note the default states before using appropriate pin.
6. In the application, wherever RS9116 is connected to external host, during power-off state, the host should ensure that all the pins (analog or digital) connected to the RS9116 are not driven. Else, the pins must be grounded.

2.2.4 Miscellaneous Pins

Pin Name	Pin Number	I/O Supply Domain	Direction	Initial State (Power up, Active Reset)	Description
NC	18,21, 22, 23, 27, 28, 32, 37, 38, 39, 40, 44, 46, 75, 78, 81, 94, 95, 96, 117, 148, 125	NA	NA	NA	No connect.

Table 4. Miscellaneous Pins

3 RS9116 CC1 Module Specifications

3.1 Absolute Maximum Ratings

Functional operation above maximum ratings are not guaranteed and may damage the device. Exposure to maximum rating conditions for extended periods may affect device reliability.

Symbol	Parameter	Min	Max	Units
T_{store}	Storage temperature	-40	+125	°C
$T_{j(max)}$	Maximum junction temperature	-	+125	°C
UULP_VBATT_1	Always-on VBATT supply to the UULP Domains	-0.5	3.63	V
VIN_3P3	I/O supplies for GPIOs	-0.5	3.63	V
SDIO_IO_VDD	I/O supplies for SDIO I/Os	-0.5	3.63	V
ULP_IO_VDD	I/O supplies for ULP GPIOs	-0.5	3.63	V
PA5G_AVDD	Power supply for the 5 GHz RF Power Amplifier	-0.5	3.63	V
RF_AVDD_BTTX	Power supply for Bluetooth Transmit circuit.	-0.5	1.21	V
RF_AVDD33	Power supply for the 5 GHz RF	-0.5	3.63	V
AVDD_1P9_3P3	Power supply for the 5 GHz RF	-0.5	3.63	V
AVDD_1P2	Power supply for the 5 GHz RF	-0.5	1.32	V
UULP_AVDD	Power supply for the always-on digital and ULP peripherals	-0.5	1.21	V
USB_AVDD_3P3	Power supply for the USB interface	-0.5	3.63	V
USB_AVDD_1P1	Power supply for the USB core	-0.5	1.26	V
USB_VBUS	USB VBUS signal from the USB connector	-0.5	5.25	V
I_{max}	Maximum Current consumption in TX mode	-	400	mA
P_{max}	RF Power Level Input to the chip	-	10	dBm
I_{Pmax}	Peak current rating for power supply	-	500	mA

Table 5. Absolute Maximum Ratings

3.2 Recommended Operating Conditions

Symbol	Parameter	Min.	Typ.	Max.	Units
$T_{ambient}$	Ambient temperature	-40	25	85	°C
UULP_VBATT_1	Always-on VBATT supply to the UULP Domains	3	3.3	3.63	V
VIN_3P3	I/O supply for GPIOs	3	3.3	3.63	V
SDIO_IO_VDD	I/O supply for SDIO I/Os	1.75/3	1.85/3.3	1.98/3.63	V
ULP_IO_VDD	I/O supply for ULP GPIOs	3	3.3	3.63	V
PA5G_AVDD	Power supply for the 2.4 GHz RF Power Amplifier	3	3.3	3.63	V
RF_AVDD_BTTX	Power supply for Bluetooth Transmit circuit.	1.0	1.1	1.2	V

Symbol	Parameter	Min.	Typ.	Max.	Units
RF_AVDD33	Power supply for the 5 GHz RF	3	3.3	3.6	V
AVDD_1P9_3P3	Power supply for the 5 GHz RF	1.9	3.3	3.6	V
AVDD_1P2	Power supply for the 5 GHz RF (1.2V)	1.05	1.1	1.2	V
UULP_AVDD	Power supply for the always-on digital and ULP peripherals	0.95	1.0	1.21	V
USB_AVDD_3P3	Power supply for the USB interface	3.0	3.3	3.63	V
USB_AVDD_1P1	Power supply for the USB core	0.99	1.1	1.21	V
USB_VBUS	USB VBUS signal from the USB connector	4.75	5	5.25	V

Table 6. Recommended Operating Conditions

3.3 DC Characteristics

3.3.1 Reset Pin

Symbol	Parameter	Min.	Typ.	Max.	Unit
V_{IH}	High level input voltage @3.3V	$0.8 * V_{DD}$	-	-	V
V_{IL}	Low level input voltage @3.3V	-	-	$0.3 * V_{DD}$	V
V_{hys}	Hysteresis voltage	$0.05 * V_{DD}$	-	-	V

Table 7. Reset Pin

All numbers are at typical operating conditions unless otherwise stated.

3.3.2 Power Sequence

The POC_IN and RESET_N signals should be controlled from external sources such as R/C circuits, and/or other MCU's GPIOs. Below waveforms show power sequence (Up & Down) requirements under various application needs. Note that below waveforms are not to scale.

3.3.2.1 Power-Up and Down Sequence with External 1.4V supply and POC_IN

The diagram below shows connections of various power supply voltages, POC_IN and RESET_N. These connections can be used when:

- System PMU (outside RS9116) can provide 1.4V supply, and hence the internal Buck regulator in RS9116 can be disabled.
- The 1.1V supply is still derived from LDO SoC (internal to RS9116).
- POC_IN is controlled externally.

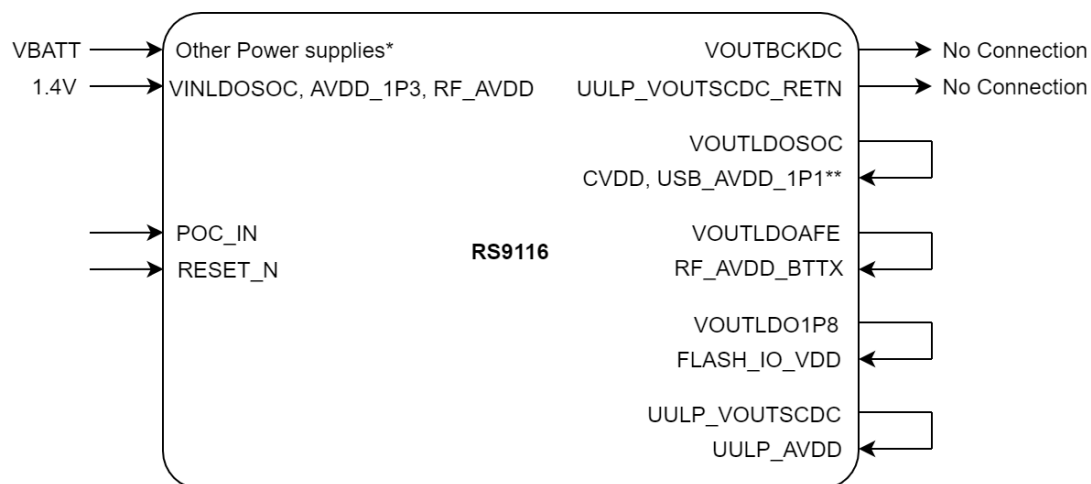

NOTE:

1. A typical connection diagram is shown above. Some of the supply pins shown above may or may not be present in the IC/Module. Check the Pinout table in this datasheet and connect accordingly.
2. * = Provide the supply voltages as per the specifications mentioned in this datasheet.
3. ** = USB power supply input connection is required if USB interface is present and used. Otherwise, follow the connection as shown in Reference Schematics.

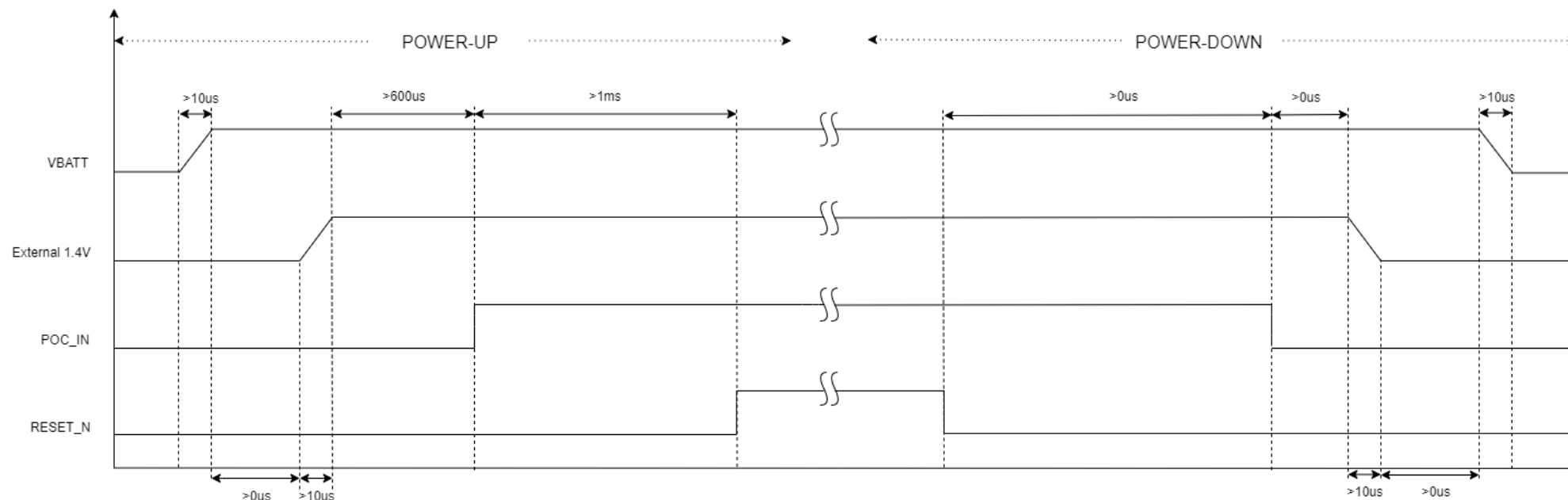

NOTE:

1. The VBATT supply shown above must be connected to the power supply pins of IC/Module. For example, SDIO_IO_VDD, ULP_IO_VDD, UULP_VBATT_1, etc.
2. The POC_IN waveform above is applicable if it is externally driven. Otherwise, that particular waveform can be ignored, and the RESET_N timing can be considered after/before external power supplies ramp-up/down.

3.3.2.2 Power-Up and Down Sequence with External POC_IN

The diagram below shows connections of various power supply voltages, POC_IN and RESET_N. These connections can be used when:

- System PMU cannot provide 1.4V or 1.1V supplies and the internal buck and LDO of RS9116 are used.
- POC_IN is controlled externally.

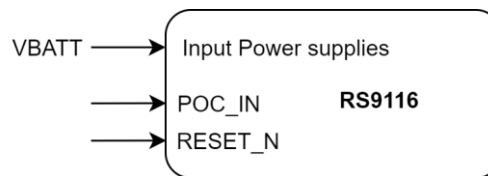

NOTE:

1. A typical connection diagram is shown above. Check the Reference Schematics for connections of other power supplies.

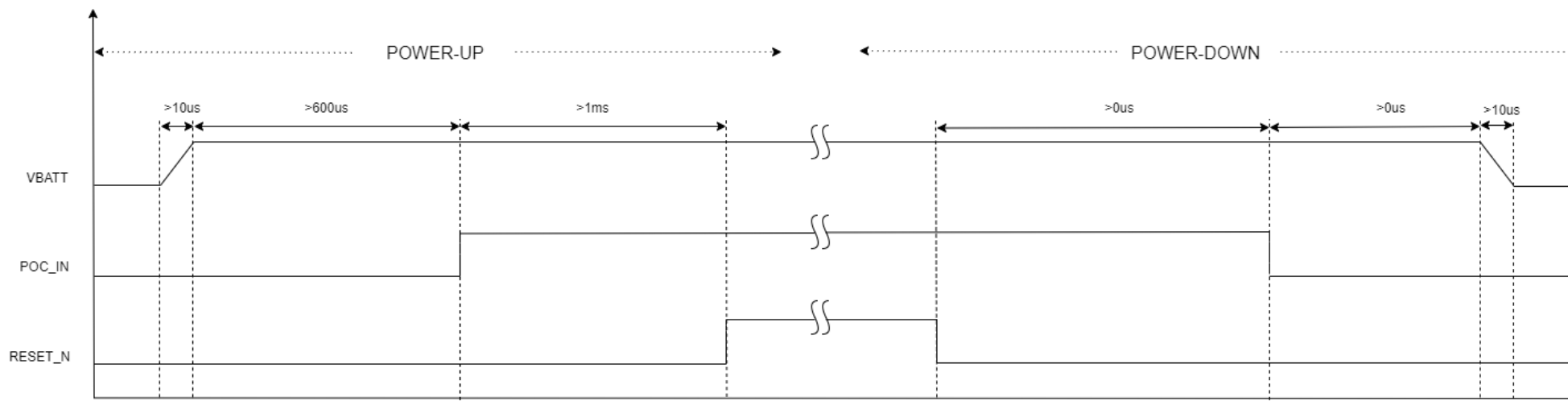

NOTE:

1. The VBATT supply shown above must be connected to the power supply pins of IC/Module. For example, SDIO_IO_VDD, ULP_IO_VDD, UULP_VBATT_1, etc.

3.3.2.3 Power-Up and Down Sequence with POC_IN Connected Internally

The diagram below shows connections of various power supply voltages, POC_IN and RESET_N. The typical applications of this connection can be as follows. This connection is **Not Recommended for New Design**.

- System cannot provide external 1.4V & 1.1V supplies and the internal buck and LDO of RS9116 are used.
- POC_IN is looped back from POC_OUT.

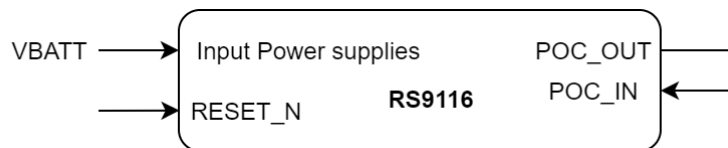

NOTE:

1. A typical connection diagram is shown above. Check the Reference Schematics for connections of other power supplies.
2. POC_OUT can be connected to POC_IN if the supply voltage is 3.3V only. Otherwise, POC_IN must be driven externally.
3. This connection is **Not Recommended for New Design**, and it is recommended to drive POC_IN externally as shown in the above section. If POC_IN cannot be driven externally, then an RC circuit delay can be provided in between POC_IN and POC_OUT, for delaying the POC_OUT signal reaching the POC_IN.

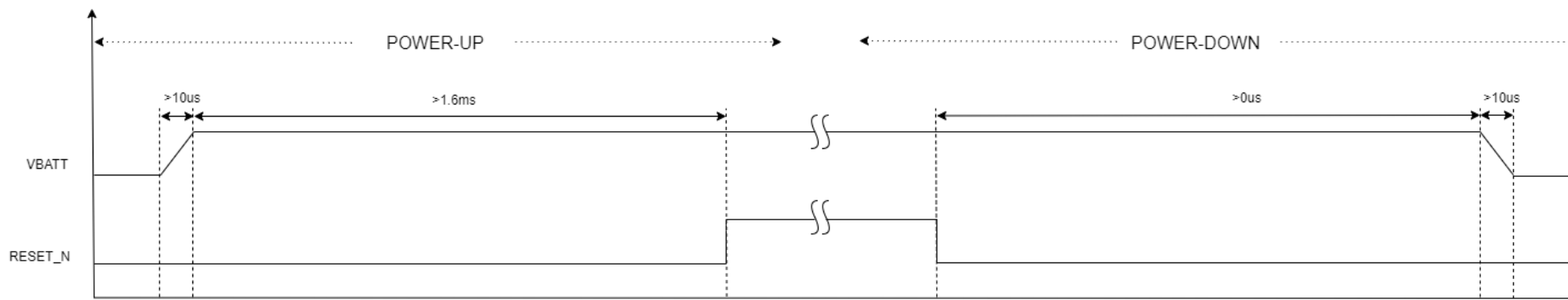

NOTE:

1. The VBATT supply shown above must be connected to the power supply pins of IC/Module. For example, SDIO_IO_VDD, ULP_IO_VDD, UULP_VBATT_1, etc.

3.3.2.4 Power-Up Sequence with EXT_PG_EN Used to Control Supply Voltages

The EXT_PG_EN functionality (available on one of the pins) can be used to control supply voltages other than UULP_VBATT supplies (Always-ON VBATT Power supplies). If EXT_PG_EN functionality is enabled, it will be '1' by default immediately after power-on. The diagram below shows typical connections of EXT_PG_EN and UULP_VBATT pins. Use one of the application connections shown above in conjunction to the below. The main purpose of this connection diagram and waveform is to show the EXT_PG_EN connection and its waveform in relation to the others.

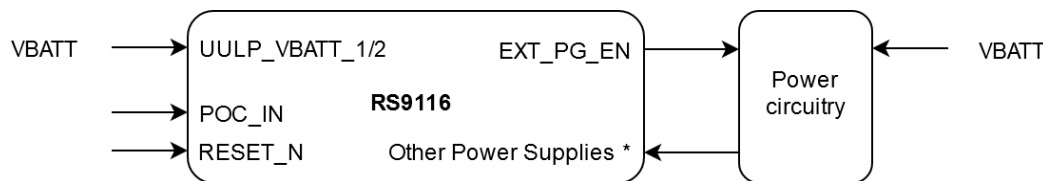

NOTE:

1. A typical connection diagram is shown above. Some of the supply pins shown above may not be present in the SoC/module. Check the PinOut table in this datasheet and connect accordingly.
2. * = Provide the supply voltages as per the specifications mentioned in the datasheet.
3. Typical Power circuitry can be a Power Gate (Transistor or IC based), or a Voltage Regulator.

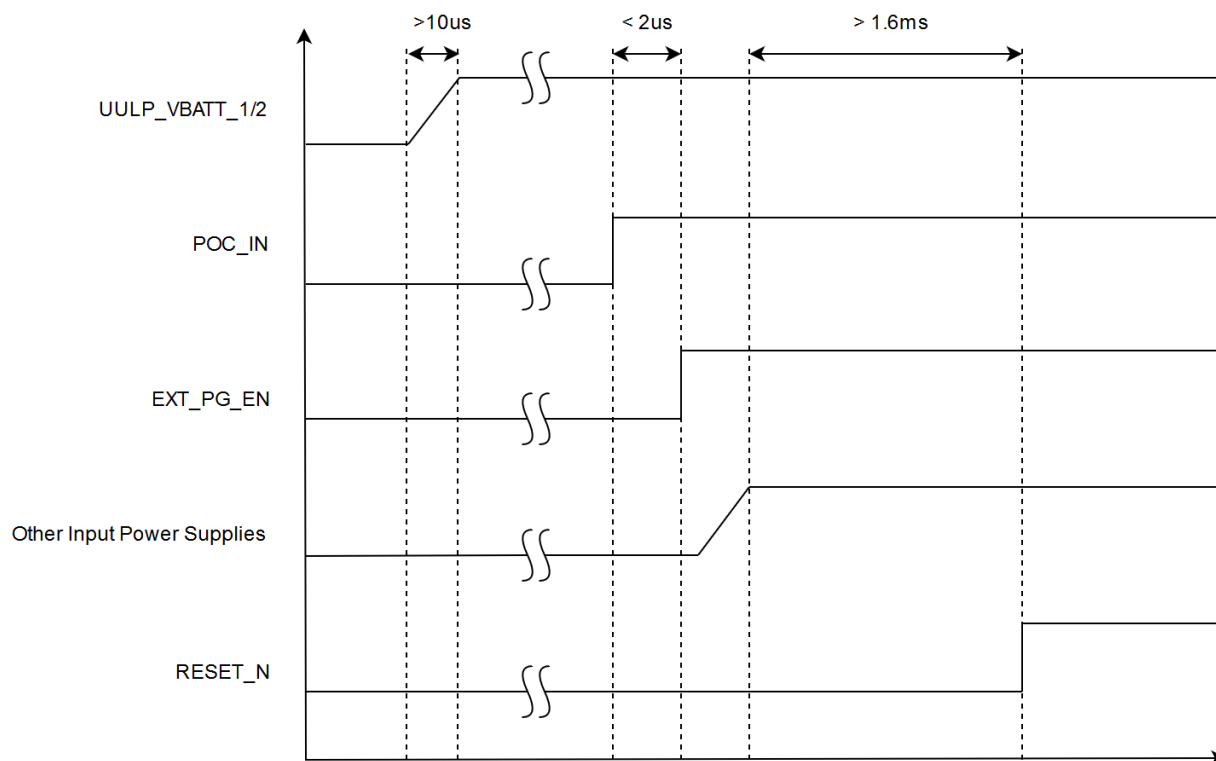
**NOTE:**

1. The waveform shown above is for a typical connection. POC_IN can be connected based on one of the above application diagrams, and its waveform/timing depends on the connection.
2. As per the EXT_PG_EN signaling, other power supplies ramp-up as per the power circuitry implementation. Hence, the start and ramp-up timing of other power supplies does not have any timing requirement.

3.3.2.5 Power-Up Sequence with USB as Host Interface

The below timing waveform is for the case when USB is used as the host interface. USB_VBUS should be supplied at 5V, and it should follow this timing waveform with respect to USB_AVDD_3P3.

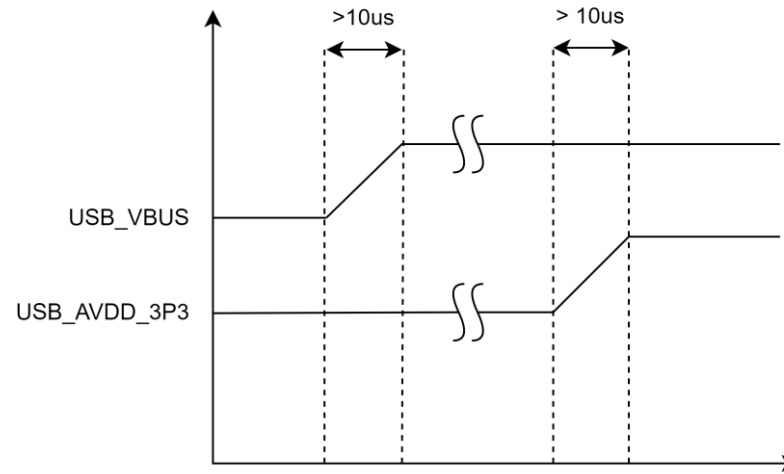

NOTE:

1. USB_AVDD_3P3 is part of the input power supply to RS9116.
2. This waveform should be followed in conjunction with the applicable waveform given in the above sections.

3.3.3 Hardware Resetting Sequence after Power On

During power-up of the RS9116, a power-up sequence must be followed as per the requirements mentioned in the above section. In some applications, there is a need to reset the RS9116 for a second time or beyond after power-up. Follow the below timing diagram in such cases. Because the POC_IN and RESET_N are applied externally, the present state of the device will be lost.

If POC_IN cannot be applied externally or POC_OUT is looped back to POC_IN, then a second reset (or beyond) cannot be applied.

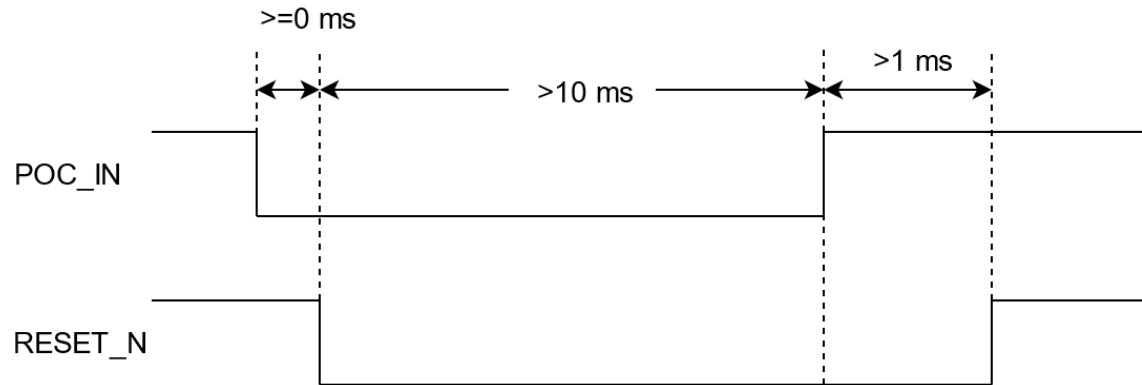

3.3.4 Digital Input Output Signals

Symbol	Parameter	Min.	Typ.	Max.	Unit
V _{IH}	High level input voltage @3.3V	2.0	-	-	V
	High level input voltage @1.8V	1.17	-	-	V
V _{IL}	Low level input voltage @3.3V	-	-	0.8	V
	Low level input voltage @1.8V	-	-	0.63	V
V _{hys}	Hysteresis voltage	0.1 VDD	-	-	V
V _{OL}	Low level output voltage	-	-	0.4	V
V _{OH}	High level output voltage	VDD-0.4	-	-	V
I _{OL}	Low level output current	-	4.0	-	mA
I _{OH}	High level output current	-	4.0	-	mA

Table 8. Digital I/O Signals

- All numbers are at typical operating conditions unless otherwise stated.
- SDIO signals will be at 8 mA drive strength.

3.3.5 USB

Parameter	Conditions	Min.	Typ.	Max.	Units
V _{cm} DC (DC level measured at receiver connector)	HS Mode	-0.05	-	0.5	V
	LS/FS Mode	0.8	-	2.5	V
Crossover Voltages	LS Mode	1.3	-	2	V
	FS Mode	1.3	-	2	V
Power supply ripple noise (Analog 3.3V)	< 160 MHz	-50	-	50	mV

Table 9. USB

3.3.6 Pin Capacitances

Symbol	Parameter	Min.	Typ.	Max.	Unit
C _{io}	Input/output capacitance, digital pins only	-	-	2.0	pF

Table 10. Pin Capacitances

3.4 AC Characteristics

3.4.1 Clock Specifications

RS9116 chipsets require two primary clocks:

- Low frequency 32 kHz clock for sleep manager and RTC
 - Internal 32 kHz RC clock is used for applications with low timing accuracy requirements
 - 32 kHz crystal clock is used for applications with high timing accuracy requirements
- High frequency 40 MHz clock for the ThreadArch® processor, baseband subsystem and the radio
 - 40 MHz clock is integrated inside the module, and no external clock needs to be provided

The chipsets have integrated internal oscillators including crystal oscillators to generate the required clocks. Integrated crystal oscillators enable the use of low-cost passive crystal components. Additionally, in a system where an external clock source is already present, the clock can be reused. The following are the recommended options for the clocks for different functionalities:

Functionality	Default Clock Option	Other Clock Option	Comments
Wi-Fi or Wi-Fi + BLE Connectivity	Internal 32 kHz RC oscillator calibrated to <200ppm	32 kHz XTAL oscillator input on UULPGPIO.	32 kHz XTAL Oscillator clock is optional. No significant power consumption impact on connected power numbers (<10uA).
Wi-Fi + BT or Wi-Fi + BT + BLE Connectivity with low power Audio Streaming operation (A2DP Source)	32 kHz XTAL oscillator input on UULPGPIO	Internal 32 kHz RC oscillator calibrated to <200ppm	32 kHz XTAL Oscillator clock is important for Low-power Audio Streaming operation (A2DP Source).

There is no impact on sleep/deep-sleep power consumption with/without 32 kHz XTAL oscillator clock

32 kHz XTAL sources:

Option 1: From Host MCU/MPU LVCMOS rail to rail clock input on UULPGPIO

Option 2: External Xtal oscillator providing LVCMOS rail to rail clock input on UULPGPIO (Nano-drive clock should not be supplied).

3.4.1.1 32 kHz Clock

The 32 kHz clock selection can be done through software. RC oscillator clock is not suited for high timing accuracy applications and can increase system current consumption in duty-cycled power modes.

3.4.1.1.1 RC Oscillator

Parameter	Parameter Description	Min	Typ.	Max	Units
F _{osc}	Oscillator Frequency		32.0		kHz
F _{osc_Acc}	Frequency Variation with Temp and Voltage		1.2		%
Jitter	RMS value of Edge jitter (TIE)		91		ns
Peak Period Jitter	Peak value of Cycle Jitter with 6 σ variation		789		ns

Table 11. 32 kHz RC Oscillator

3.4.1.1.2 32 kHz External Oscillator

An external 32 kHz low-frequency clock can be fed through the XTAL_32KHZ_IN functionality.

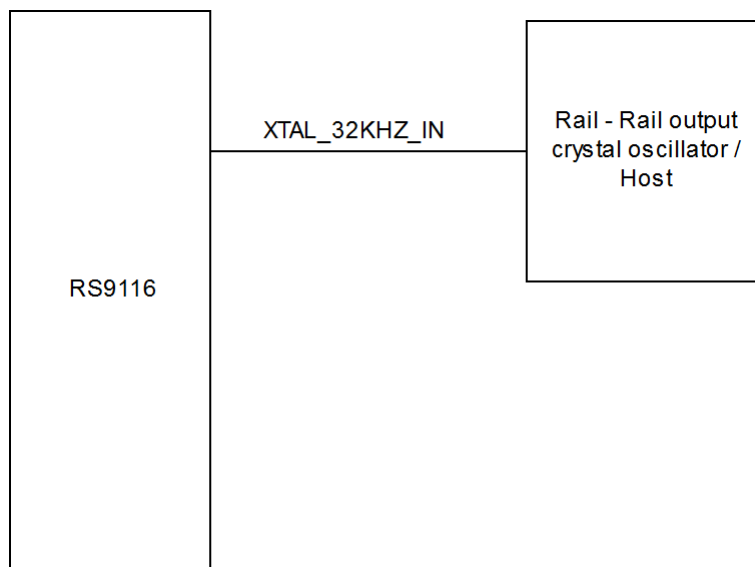

Figure 6. External 32 kHz Oscillator - Rail to Rail

Parameter	Parameter Description	Min	Typ.	Max	Units
F_{osc}	Oscillator Frequency		32.768		kHz
F_{osc_Acc}	Frequency Variation with Temp and Voltage	-100		100	ppm
Duty cycle	Input duty cycle	30	50	70	%
V_{AC}	Input AC peak-peak voltage swing at input pin.	-0.3	-	$VBATT \pm 10\%$	Vpp

Table 12. 32 kHz External Oscillator Specifications

3.4.2 SDIO 2.0 Secondary

3.4.2.1 Full Speed Mode

Parameter	Parameter Description	Min.	Typ.	Max.	Unit
T_{sdio}	SDIO_CLK	-	-	25	MHz
T_s	SDIO_DATA/SDIO_CMD, input setup time	4	-	-	ns
T_h	SDIO_DATA/SDIO_CMD, input hold time	1	-	-	ns
T_{od}	SDIO_DATA/SDIO_CMD, clock to output delay	-	-	13	ns
C_L	Output Load	5	-	10	pF

Table 13. AC Characteristics - SDIO 2.0 Secondary Full Speed Mode

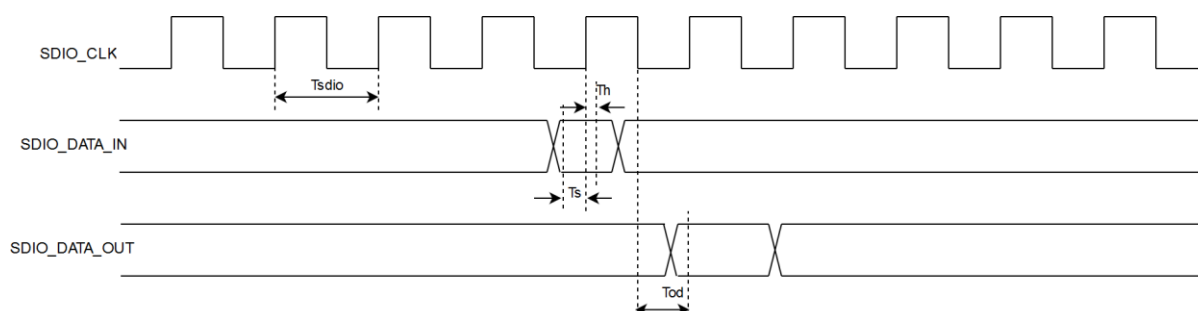

Figure 7. Interface Timing Diagram for SDIO 2.0 Secondary Full Speed Mode

3.4.2.2 High Speed Mode

Parameter	Parameter Description	Min.	Typ.	Max.	Unit
T_{sdio}	SDIO_CLK	25	-	50	MHz
T_s	SDIO_DATA/SDIO_CMD, input setup time	4	-	-	ns
T_h	SDIO_DATA/SDIO_CMD, input hold time	1	-	-	ns
T_{od}	SDIO_DATA/SDIO_CMD, clock to output delay	2.5	-	13	ns
C_L	Output Load	5	-	10	pF

Table 14. AC Characteristics - SDIO 2.0 Secondary High-Speed Mode

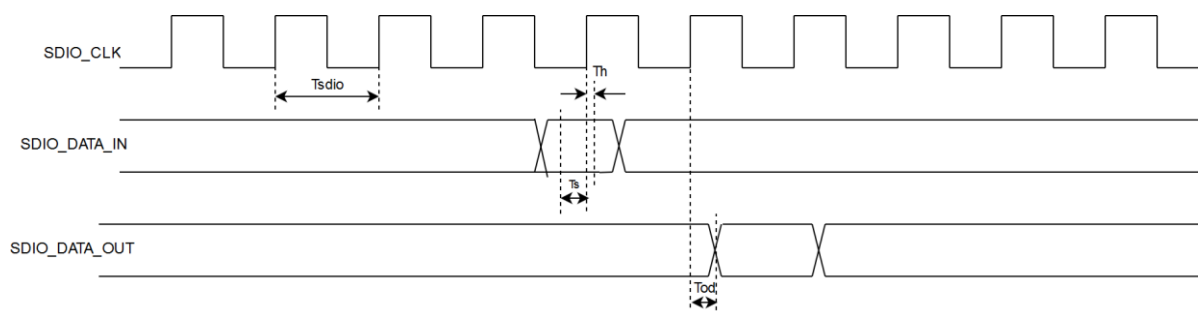

Figure 8. Interface Timing Diagram for SDIO 2.0 Secondary High-Speed Mode

3.4.3 SPI Secondary

3.4.3.1 Low Speed Mode

Parameter	Parameter Description	Min.	Typ.	Max.	Unit
T_{spi}	SPI_CLK	0	-	25	MHz
T_{cs}	SPI_CS to output delay	-	-	7.5	ns
T_{cst}	SPI CS to input setup time	4.5	-	-	-
T_s	SPI_MOSI, input setup time	1.33	-	-	ns
T_h	SPI_MOSI, input hold time	1.2	-	-	ns
T_{od}	SPI_MISO, clock to output delay	-	-	8.75	ns
C_L	Output Load	5	-	10	pF

Table 15. AC Characteristics - SPI Secondary Low Speed Mode

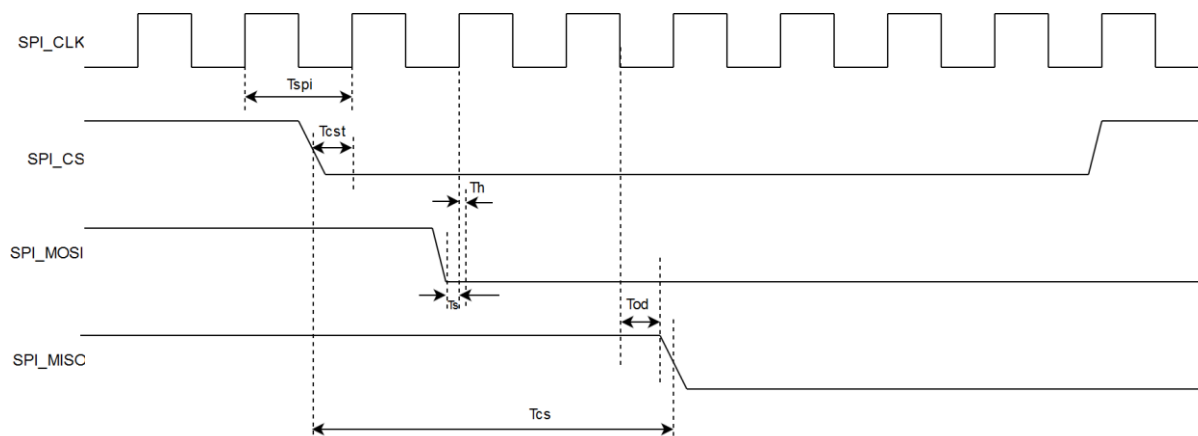

Figure 9. Interface Timing Diagram for SPI Secondary Low Speed Mode

3.4.3.2 High Speed Mode

Parameter	Parameter Description	Min.	Typ.	Max.	Unit
T_{spi}	SPI_CLK	25	-	80	MHz
T_{cs}	SPI_CS to output delay	-	-	7.5	ns
T_{cst}	SPI CS to input setup time	4.5	-	-	-
T_s	SPI_MOSI, input setup time	1.33	-	-	ns
T_h	SPI_MOSI, input hold time	1.2	-	-	ns
T_{od}	SPI_MISO, clock to output delay	2.5	-	8.75	ns
C_L	Output Load	5	-	10	pF

Table 16. AC Characteristics - SPI Secondary High-Speed Mode

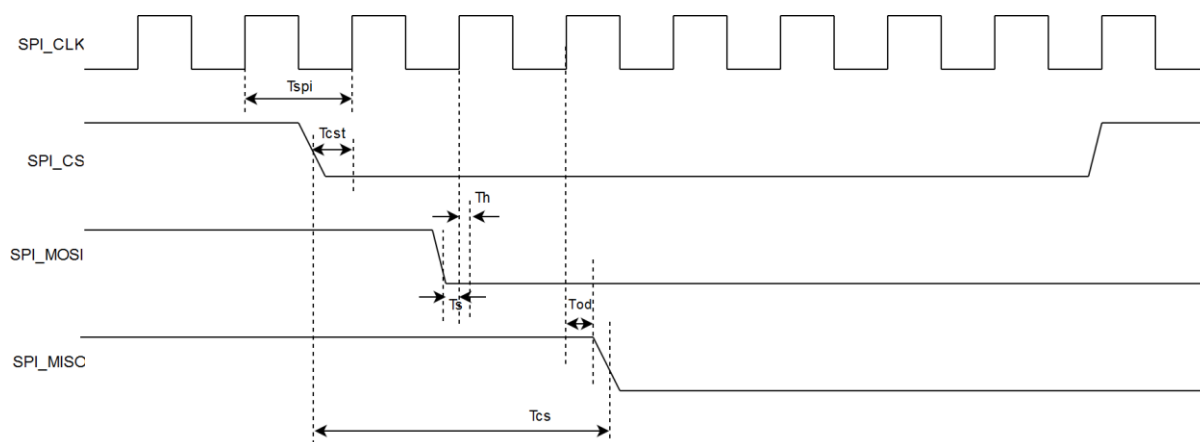

Figure 10. Interface Timing Diagram for SPI Secondary High-Speed Mode

3.4.3.3 Ultra-High-Speed Mode

Parameter	Parameter Description	Min.	Typ.	Max.	Unit
T_{spi}	SPI_CLK	-	-	100	MHz
T_s	SPI_MOSI, input setup time	1.33	-	-	ns
T_h	SPI_MOSI, input hold time	1.2	-	-	ns
T_{od}	SPI_MISO, clock to output delay	1.5	-	8.75	ns
C_L	Output Load	5	-	10	pF

Table 17. AC Characteristics - SPI Secondary Ultra High Speed Mode

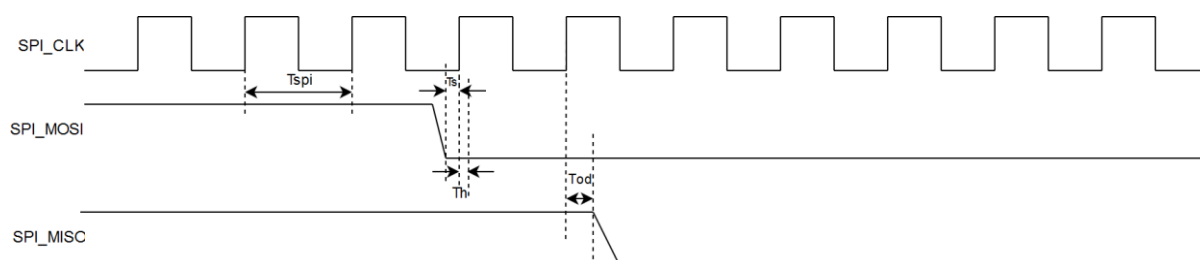

Figure 11. Interface Timing Diagram for SPI Secondary Ultra High Speed Mode

3.4.4 USB

3.4.4.1 Low Speed Mode

Parameter	Parameter Description	Min.	Typ.	Max.	Unit
T_r	Rise Time	75	-	300	ns
T_f	Fall Time	75	-	300	ns
Jitter	Jitter	-	-	10	ns

Table 18. AC Characteristics - USB Low Speed Mode

3.4.4.2 Full Speed Mode

Parameter	Parameter	Min.	Typ.	Max.	Unit
T_r	Rise Time	4	-	20	ns
T_f	Fall Time	4	-	20	ns
Jitter	Jitter	-	-	1	ns

Table 19. AC Characteristics - USB Full Speed Mode

3.4.4.3 High Speed Mode

Parameter	Parameter Description	Min.	Typ.	Max.	Unit
T_r	Rise Time	0.5	-	-	ns
T_f	Fall Time	0.5	-	-	ns
Jitter	Jitter	-	-	0.1	ns

Table 20. AC Characteristics - USB High Speed Mode

3.4.5 UART

Parameter	Parameter Description	Min.	Typ.	Max.	Unit
T_{uart}	CLK	0	-	20	MHz
T_{od}	Output delay	0	-	10	ns
T_s	Input setup time	0	-	5	ns
C_L	Output load	5	-	25	pF

Table 21. AC Characteristics - UART

3.4.6 I2C Main and Secondary

3.4.6.1 Fast Speed Mode

Parameter	Parameter Description	Min.	Typ.	Max.	Unit
T_{i2c}	SCL	100	-	400	KHz
T_{low}	clock low period	1.3	-	-	us
T_{high}	clock high period	0.6	-	-	us
T_{sstart}	start condition, setup time	0.6	-	-	us
T_{hstart}	start condition, hold time	0.6	-	-	us
T_s	data, setup time	100	-	-	ns

Parameter	Parameter Description	Min.	Typ.	Max.	Unit
T_{sstop}	stop condition, setup time	0.6	-	-	us
C_L	Output Load	5	-	10	pF

Table 22. AC Characteristics - I2C Fast Speed Mode

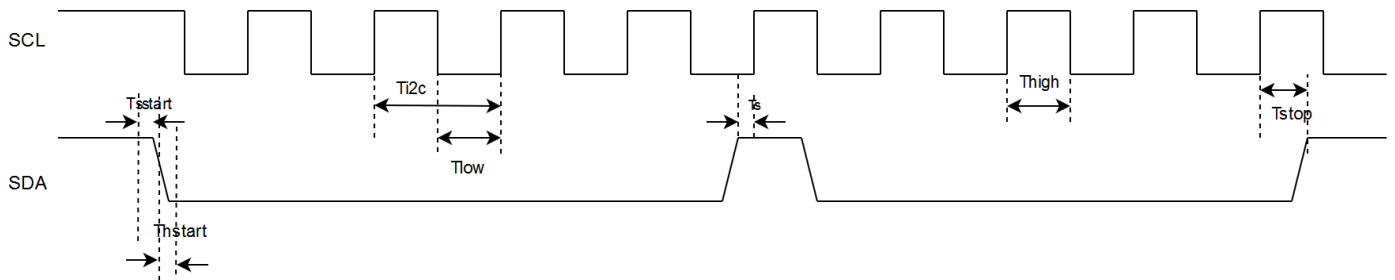

Figure 12. Interface Timing Diagram for I2C Fast Speed Mode

3.4.6.2 High Speed Mode

Parameter	Parameter Description	Min.	Typ.	Max.	Unit
T_{i2c}	SCL	0.4	-	3.4	MHz
T_{low}	clock low period	160	-	-	ns
T_{high}	clock high period	60	-	-	ns
T_{sstart}	start condition, setup time	160	-	-	ns
T_{hstart}	start condition, hold time	160	-	-	ns
T_s	data, setup time	10	-	-	ns
T_h	data, hold time	0	-	70	ns
T_{sstop}	stop condition, setup time	160	-	-	ns
C_L	Output Load	5	-	10	pF

Table 23. AC Characteristics - I2C High Speed Mode

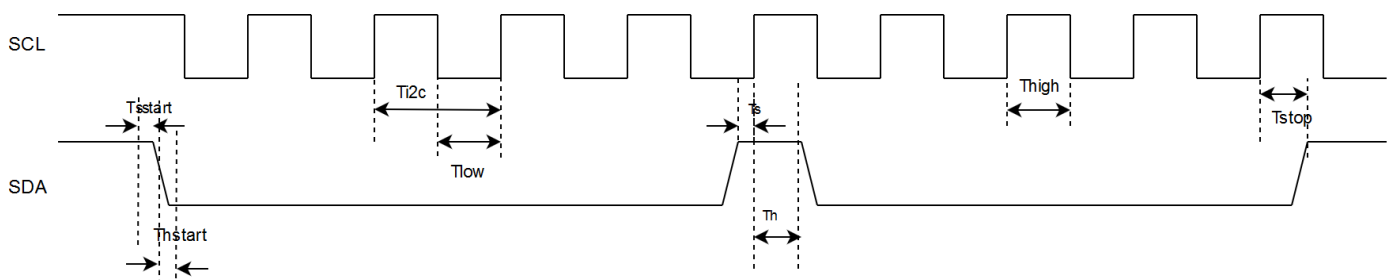

Figure 13. Interface Timing Diagram for I2C High Speed Mode

3.4.7 I2S/PCM Main and Secondary

3.4.7.1 Main Mode

Negedge driving and posedge sampling for I2S
 Posedge driving and negedge sampling for PCM

Parameter	Parameter Description	Min.	Typ.	Max.	Unit
T_{i2s}	i2s_clk	0	-	25	MHz
T_s	i2s_din, i2s_ws setup time	10	-	-	ns

Parameter	Parameter Description	Min.	Typ.	Max.	Unit
T_h	i2s_din, i2s_ws hold time	0	-	-	ns
T_{od}	i2s_dout output delay	0	-	12	ns
C_L	i2s_dout output load	5	-	10	pF

Table 24. AC Characteristics – I2S/PCM Main Mode

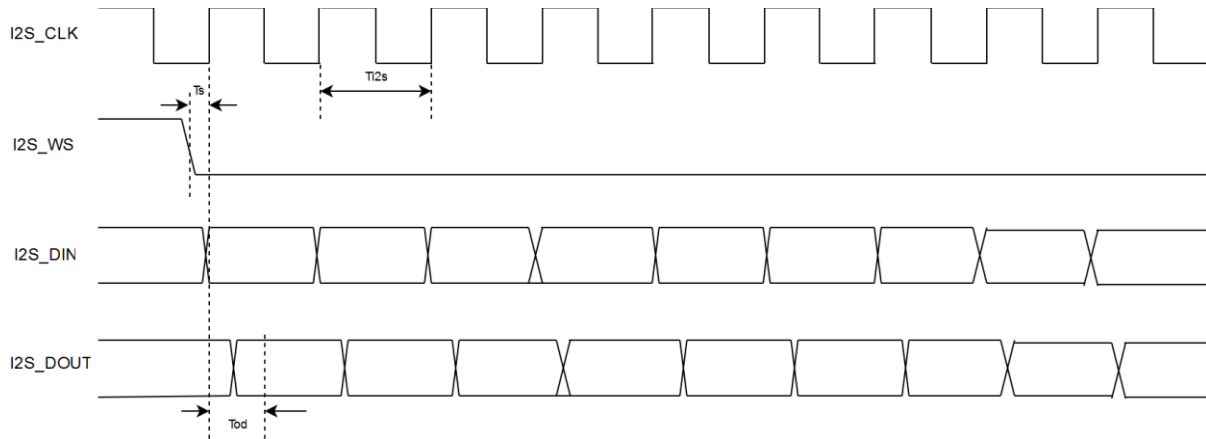

Figure 14. Interface Timing Diagram for I2S Main Mode

3.4.7.2 Secondary Mode

Negedge driving and posedge sampling for I2S
 Posedge driving and negedge sampling for PCM

Parameter	Parameter Description	Min.	Typ.	Max.	Unit
T_{i2s}	i2s_clk	0	-	25	MHz
T_s	i2s_din, i2s_ws setup time	8	-	-	ns
T_h	i2s_din, i2s_ws hold time	0	-	-	ns
T_{od}	i2s_dout output delay	0	-	17	ns
C_L	i2s_dout output load	5	-	10	pF

Table 25. AC Characteristics - I2S/PCM Secondary Mode

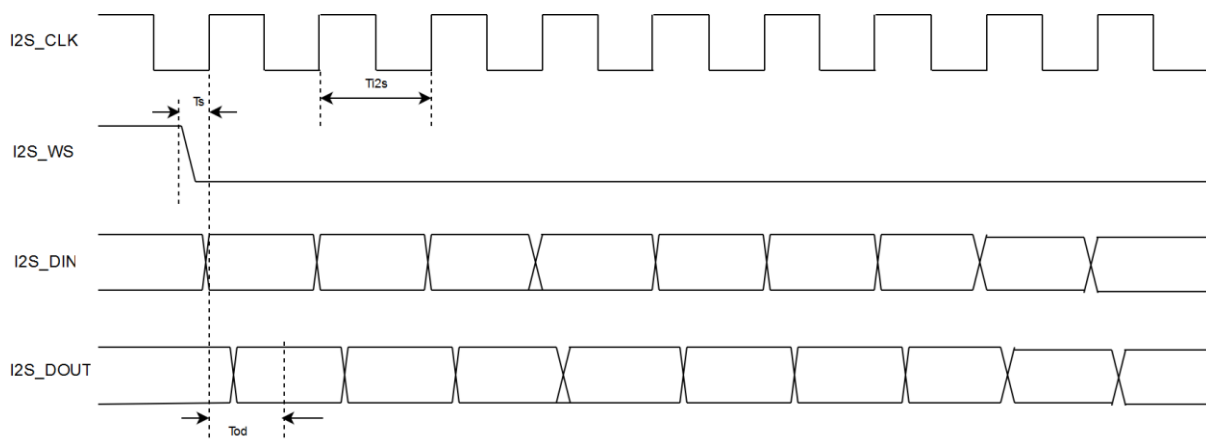

Figure 15. Interface Timing Diagram for I2S Secondary Mode

3.4.8 GPIO pins

Parameter	Parameter Description	Conditions	Min.	Typ.	Max.	Unit
T _{rf}	Rise time	Pin configured as output; SLEW = 1 (fast mode)	1.0	-	2.5	ns
T _{ff}	Fall time	Pin configured as output; SLEW = 1 (fast mode)	0.9	-	2.5	ns
T _{rs}	Rise time	Pin configured as output; SLEW = 0 (standard mode)	1.9	-	4.3	ns
T _{fs}	Fall time	Pin configured as output; SLEW = 0 (standard mode)	1.9	-	4.0	ns
T _r	Rise time	Pin configured as input	0.3	-	1.3	ns
T _f	Fall time	Pin configured as input	0.2	-	1.2	ns

Table 26. AC Characteristics - GPIO Pins

3.5 RF Characteristics

In the sub-sections below, all numbers are measured at typical operating conditions unless otherwise stated.

3.5.1 WLAN 2.4 GHz Transmitter Characteristics

3.5.1.1 Transmitter Characteristics with 3.3V Supply

- TA = 25°C. Remaining supplies are at typical operating conditions.
- The transmit power numbers are based on average performance across channels.

Parameter	Condition	Notes	Min	Typ.	Max	Units
Transmit Power for 20 MHz Bandwidth, compliant with IEEE mask and EVM	DSSS - 1 Mbps	EVM< -9 dB	-	17.5	-	dBm
	DSSS - 2 Mbps	EVM< -9 dB	-	17.5	-	dBm
	CCK - 5.5 Mbps	EVM< -9 dB	-	17.5	-	dBm
	CCK - 11 Mbps	EVM< -9 dB	-	15.5	-	dBm
	OFDM - 6 Mbps	EVM< -5 dB	-	16.5	-	dBm
	OFDM - 9 Mbps	EVM< -8 dB	-	15.5	-	dBm
	OFDM - 12 Mbps	EVM< -10 dB	-	15.5	-	dBm
	OFDM - 18 Mbps	EVM< -13 dB	-	16	-	dBm
	OFDM - 24 Mbps	EVM< -16 dB	-	15.5	-	dBm
	OFDM - 36 Mbps	EVM< -19 dB	-	13.5	-	dBm
OFDM - 48 Mbps	EVM< -22 dB	-	13	-	dBm	

Parameter	Condition	Notes	Min	Typ.	Max	Units
	OFDM - 54 Mbps	EVM< -25 dB	-	13	-	dBm
	MCS0 Mixed Mode	EVM< -5 dB	-	16	-	dBm
	MCS1 Mixed Mode	EVM< -10 dB	-	16	-	dBm
	MCS2 Mixed Mode	EVM< -13 dB	-	16	-	dBm
	MCS3 Mixed Mode	EVM< -16 dB	-	15.5	-	dBm
	MCS4 Mixed Mode	EVM< -19 dB	-	13.5	-	dBm
	MCS5 Mixed Mode	EVM< -22 dB	-	12.5	-	dBm
	MCS6 Mixed Mode	EVM< -25 dB (See note section)	-	12.5	-	dBm
	MCS7 Mixed Mode	(See note section)	-	11	-	dBm
Transmitter Emissions (6 Mbps @ Maximum Power)	776-794 MHz	CDMA2000	-	-148	-	dBm/Hz
	869-960 MHz	CDMAOne, GSM850	-	-158	-	dBm/Hz
	1450-1495 MHz	DAB	-	-151	-	dBm/Hz
	1570-1580 MHz	GPS	-	-151	-	dBm/Hz
	1592-1610 MHz	GLONASS	-	-132	-	dBm/Hz
	1710-1800 MHz	DSC-1800-Uplink	-	-130	-	dBm/Hz
	1805-1880 MHz	GSM 1800	-	-110	-	dBm/Hz
	1850-1910 MHz	GSM 1900	-	-122	-	dBm/Hz
	1910-1930 MHz	TDSCDMA, LTE	-	-135	-	dBm/Hz
	1930-1990 MHz	GSM1900, CDMAOne, WCDMA	-	-130	-	dBm/Hz
	2010-2075 MHz	TDSCDMA	-	-127	-	dBm/Hz
	2110-2170 MHz	WCDMA	-	-119	-	dBm/Hz
	2305-2370 MHz	LTE Band 40	-	-112	-	dBm/Hz
	2370-2400 MHz	LTE Band 40	-	-95	-	dBm/Hz
	2496-2530 MHz	LTE Band 41	-	-102	-	dBm/Hz
	2530-2560 MHz	LTE Band 41	-	-113	-	dBm/Hz
2570-2690 MHz	LTE Band 41	-	-128	-	dBm/Hz	
5000-5900 MHz	WLAN 5G	-	-148	-	dBm/Hz	

Parameter	Condition	Notes	Min	Typ.	Max	Units
Harmonic Emissions (1 Mbps @ Maximum Power)	4.8-5.0 GHz	2nd Harmonic	-	-40	-	dBm/MHz
	7.2-7.5 GHz	3rd Harmonic	-	-43	-	dBm/MHz

Table 27. WLAN 2.4 GHz Transmitter Characteristics (3.3V)

1. There is a variation of up to +/-1dB in power across channels.
2. To meet FCC emission limits, band edge channels (1 and 11) TX Power must be reduced by up to 4 dB in lower data rates and up to 3 dB in higher data rates. The radiated power in band edge is a strong function of the antenna properties. Refer to AN1337 application note for more details on the certifications.
3. The output power may degrade by up to 6 dB over the operating temperature range of -40 °C to +85 °C.
4. There may be a reduction in EVM of up to 2 dB in MCS6 data rate.
5. EVM for MCS7 data rate may not meet IEEE spec of -27dB.
6. IEEE spectral mask limits may be crossed in lower data rates in some channels, and if required power may be backed off by 1-2 dB.
7. There is a +/-2dB of 3 sigma (99.7%) part-to-part power variation.

3.5.2 WLAN 2.4 GHz Receiver Characteristics on High-Performance (HP) RF Chain

TA = 25°C. Parameters are measured at antenna port on channel 1(2412 MHz)

- All WLAN receiver sensitivity numbers and adjacent channel numbers are at < 10% PER limit. Packet sizes are 1024 bytes for 802.11 b/g data rates and 4096 bytes for 802.11 n data rates.
- For WLAN ACI cases, the desired signal power is 3 dB above standard defined sensitivity level.

Parameter	Condition/Notes	Min	Typ.	Max	Units
Sensitivity for 20 MHz Bandwidth (1)	1 Mbps DSSS	-	-96	-	dBm
	2 Mbps DSSS	-	-90	-	dBm
	5.5 Mbps CCK	-	-89	-	dBm
	11 Mbps CCK	-	-86.5	-	dBm
	6 Mbps OFDM	-	-90	-	dBm
	9 Mbps OFDM	-	-89	-	dBm
	12 Mbps OFDM	-	-89	-	dBm
	18 Mbps OFDM	-	-87	-	dBm
	24 Mbps OFDM	-	-84	-	dBm
	36 Mbps OFDM	-	-80	-	dBm
	48 Mbps OFDM	-	-75.5	-	dBm
	54 Mbps OFDM	-	-74	-	dBm
	MCS0 Mixed Mode	-	-89.5	-	dBm
	MCS1 Mixed Mode	-	-87	-	dBm
MCS2 Mixed Mode	-	-84	-	dBm	

Parameter	Condition/Notes	Min	Typ.	Max	Units
	MCS3 Mixed Mode	-	-82	-	dBm
	MCS4 Mixed Mode	-	-78	-	dBm
	MCS5 Mixed Mode	-	-73	-	dBm
	MCS6 Mixed Mode	-	-71	-	dBm
	MCS7 Mixed Mode	-	-70	-	dBm
Maximum Input Level for PER below 10%	802.11 b	-	8	-	dBm
	802.11g	-	-10	-	dBm
	802.11n	-	-10	-	dBm
RSSI Accuracy Range		-3	-	3	dB
Blocking level for 3 dB RX Sensitivity Degradation (Data rate 6Mbps OFDM, Desired signal at -79dBm)	776–794 MHz	-	-6	-	dBm
	824–849 MHz	-	-5	-	dBm
	880–915 MHz	-	-8	-	dBm
	1710–1785 MHz	-	-21	-	dBm
	1850–1910 MHz	-	-17	-	dBm
	1920–1980 MHz	-	-20	-	dBm
	2300–2400 MHz	-	-58	-	dBm
	2570–2620 MHz	-	-22	-	dBm
	2545–2575 MHz	-	-20	-	dBm
Return Loss		-10	-	-	dB
Adjacent Channel Interference	1 Mbps DSSS	-	36	-	dB
	11 Mbps DSSS	-	37	-	dB
	6 Mbps OFDM	-	38	-	dB
	54 Mbps OFDM	-	22	-	dB
	MCS0 Mixed Mode	-	38	-	dB
	MCS7 Mixed Mode	-	20	-	dB
Alternate Adjacent Channel Interference	1 Mbps DSSS	-	44	-	dB
	11 Mbps DSSS	-	35	-	dB
	6 Mbps OFDM	-	46	-	dB
	54 Mbps OFDM	-	30	-	dB
	MCS0 Mixed Mode	-	46	-	dB
	MCS7 Mixed Mode	-	28	-	dB

Table 28. WLAN 2.4 GHz Receiver Characteristics on HP RF Chain

- Receiver sensitivity may be degraded by up to 4 dB for channels 6,7,8,13,14 due to desensitization of the receiver by harmonics of the system clock (40 MHz).

2. There may be a degradation of up to 2 dB across the operating temperature range of -40 °C to +85 °C.

3.5.3 WLAN 2.4 GHz Receiver Characteristics on Low-Power (LP) RF Chain

TA = 25°C. Parameters are measured at antenna port on channel 1(2412 MHz)

Parameter	Condition	Min	Typ.	Max	Units
Sensitivity for 20 MHz Bandwidth (1)	1 Mbps DSSS	-	-94	-	dBm
	2 Mbps DSSS	-	-87.5	-	dBm
	5.5 Mbps CCK	-	-86.5	-	dBm
	11 Mbps CCK	-	-83.5	-	dBm
	6 Mbps OFDM	-	-87.5	-	dBm
	9 Mbps OFDM	-	-87	-	dBm
	12 Mbps OFDM	-	-86.5	-	dBm
	18 Mbps OFDM	-	-84	-	dBm
	24 Mbps OFDM	-	-81	-	dBm
	36 Mbps OFDM	-	-77	-	dBm
	MCS0 Mixed Mode	-	-87	-	dBm
	MCS1 Mixed Mode	-	-84.5	-	dBm
	MCS2 Mixed Mode	-	-82	-	dBm
	MCS3 Mixed Mode	-	-79	-	dBm
MCS4 Mixed Mode	-	-75	-	dBm	
Maximum Input Level for PER below 10%	802.11 b	-	0	-	dBm
	802.11g	-	-10	-	dBm
	802.11n	-	-10	-	dBm
RSSI Accuracy Range		-3	-	3	dB
Blocking level for 3 dB RX Sensitivity Degradation (Data rate 6Mbps OFDM, Desired signal at - 79dBm)	776–794 MHz	-	-8	-	dBm
	824–849 MHz	-	-8	-	dBm
	880–915 MHz	-	-10	-	dBm
	1710–1785 MHz	-	-16	-	dBm
	1850–1910 MHz	-	-14	-	dBm
	1920–1980 MHz	-	-20	-	dBm
	2300–2400 MHz	-	-55	-	dBm
	2570–2620 MHz	-	-24	-	dBm
	2545–2575 MHz	-	-23	-	dBm

Parameter	Condition	Min	Typ.	Max	Units
Return Loss		-10	-	-	dB
Adjacent Channel Interference	1 Mbps DSSS	-	40	-	dB
	11 Mbps DSSS	-	36	-	dB
	6 Mbps OFDM	-	42	-	dB
	36 Mbps OFDM	-	30	-	dB
	MCS0 Mixed Mode	-	40	-	dB
	MCS4 Mixed Mode	-	30	-	dB
Alternate Adjacent Channel Interference	1 Mbps DSSS	-	50	-	dB
	11 Mbps DSSS	-	38	-	dB
	6 Mbps OFDM	-	48	-	dB
	36 Mbps OFDM	-	38	-	dB
	MCS0 Mixed Mode	-	48	-	dB
	MCS4 Mixed Mode	-	36	-	dB

Table 29. WLAN 2.4 GHz Receiver Characteristics on LP RF Chain

- Receiver sensitivity may be degraded by up to 4 dB for channels 6,7,8,13,14 due to desensitization of the receiver by harmonics of the system clock (40 MHz).
- There may be a degradation of up to 2 dB across the operating temperature range of -40 °C to +85 °C.

3.5.4 Bluetooth Transmitter Characteristics on High-Performance (HP) RF Chain

3.5.4.1 Transmitter Characteristics with 3.3 V Supply

TA = 25°C. Remaining supplies are at typical operating conditions. Parameters are measured at the antenna port. ⁽¹⁾

- For Bluetooth C/I cases, the desired signal power is 3 dB above standard defined sensitivity level.

Parameter	Condition	Notes	Min	Typ.	Max	Units
Transmit Power	BR		-	12	-	dBm
	EDR 2Mbps		-	12	-	dBm
	EDR 3Mbps		-	11	-	dBm
	LE 1Mbps		-	17	-	dBm
	LE 2Mbps		-	17	-	dBm
	LR 500 Kbps		-	17	-	dBm
	LR 125 Kbps		-	17	-	dBm
Power Control Step	BR, EDR		-	3	-	dB
Adjacent Channel Power M-N = 2	BR		-	-	-20	dBm

Parameter	Condition	Notes	Min	Typ.	Max	Units
	EDR		-	-	-20	dBm
	LE		-	-	-20	dBm
	LR		-	-	-20	dBm
Adjacent Channel Power M-N > 2	BR		-	-	-40	dBm
	EDR		-	-	-40	dBm
	LE		-	-	-30	dBm
	LR		-	-	-30	dBm
BR Modulation Characteristics	DH1		-25	-	25	kHz
	DH3		-40	-	40	kHz
	DH5		-40	-	40	kHz
	Drift Rate		-20	-	20	kHz/50 us
	$\Delta f1$ Avg		140	-	175	kHz
	$\Delta f2$ Max		115	-		kHz
EDR Modulation Characteristics	RMS DEVM, EDR2		-	15	-	%
	RMS DEVM, EDR3		-	5.5	-	%
	99% DEVM, EDR2		-	23	-	%
	99% DEVM, EDR3		-	9.5	-	%
	peak DEVM, EDR2		-	28	-	%
	peak DEVM, EDR3		-	13.5	-	%
BLE Modulation Characteristics	$\Delta f1$ Avg		225	-	275	kHz
	$\Delta f2$ Max		185	-	-	kHz
	$\Delta f2$ Avg/ $\Delta f1$ Avg		0.8	-	-	-
Transmitter Emissions (BR @Maximum output power)	776-794 MHz	CDMA2000	-	-160	-	dBm/Hz
	869-960 MHz	CDMAOne, GSM850	-	-160	-	dBm/Hz
	1450-1495 MHz	DAB	-	-160	-	dBm/Hz
	1570-1580 MHz	GPS	-	-160	-	dBm/Hz
	1592-1610 MHz	GLONASS	-	-160 ⁽²⁾	-	dBm/Hz
	1710-1800 MHz	DSC-1800-Uplink	-	-115	-	dBm/Hz
	1805-1880 MHz	GSM 1800	-	-148	-	dBm/Hz
	1850-1910 MHz	GSM 1900	-	-148	-	dBm/Hz
	1910-1930 MHz	TDSCDMA, LTE	-	-135	-	dBm/Hz

Parameter	Condition	Notes	Min	Typ.	Max	Units
	1930–1990 MHz	GSM1900, CDMAOne, WCDMA	-	-101	-	dBm/Hz
	2010–2075 MHz	TDSCDMA	-	-148	-	dBm/Hz
	2110–2170 MHz	WCDMA	-	-115	-	dBm/Hz
	2305–2370 MHz	LTE Band 40	-	-140	-	dBm/Hz
	2370–2400 MHz	LTE Band 40	-	-134	-	dBm/Hz
	2496–2530 MHz	LTE Band 41	-	-125	-	dBm/Hz
	2530–2560 MHz	LTE Band 41	-	-138	-	dBm/Hz
	2570–2690 MHz	LTE Band 41	-	-138	-	dBm/Hz
	5000–5900 MHz	WLAN 5G	-	-148	-	dBm/Hz

Table 30. Bluetooth Transmitter Characteristics on HP RF Chain 3.3V

1. There is a variation of up to +/-1dB in power across channels.
2. Noise-floor is -160dBm/Hz with spurious tone power of -68dBm at 1601.33 MHz when the transmitted signal is at 2402 MHz.
3. There is a +/-2dB of 3 sigma (99.7%) part-to-part power variation.

3.5.5 Bluetooth Transmitter Characteristics on Low-Power (LP) 0 dBm RF Chain

TA = 25°C. Parameters are measured at the antenna port.

Parameter	Condition/Notes	Min	Typ.	Max	Units
Transmit Power	BR	-	-	-3.5	dBm
	LE 1Mbps	-	-	-3.5	dBm
	LE 2Mbps	-	-	-3.5	dBm
	LR 500 Kbps	-	-	-3.5	dBm
	LR 125 kbps	-	-	-3.5	dBm
Adjacent Channel Power M-N = 2	BR	-	-	-20	dBm
	LE	-	-	-20	dBm
	LR	-	-	-20	dBm
Adjacent Channel Power M-N > 2	BR	-	-	-40	dBm
	LE	-	-	-30	dBm
	LR	-	-	-30	dBm
BR Modulation Characteristics	DH1	-25	-	25	kHz
	DH3	-40	-	40	kHz

Parameter	Condition/Notes	Min	Typ.	Max	Units
	DH5	-40	-	40	kHz
	Drift Rate	-20	-	20	kHz
	$\Delta f1$ Avg	140	-	175	kHz
	$\Delta f2$ Max	115	-	-	kHz
BLE Modulation Characteristics	$\Delta f1$ Avg	225	-	275	kHz
	$\Delta f2$ Max	185	-	-	kHz
	$\Delta f2$ Avg/ $\Delta f1$ Avg	0.8	1.5	-	-

Table 31. Bluetooth Transmitter Characteristics on LP 0 dBm RF Chain

1. There is a variation of up to 2 dB in power across parts and channels.
2. Noise-floor is -160dBm/Hz with spurious tone power of -68dBm at 1601.33 MHz when the transmitted signal is at 2402 MHz.

3.5.6 Bluetooth Receiver Characteristics on High-Performance (HP) RF Chain

TA = 25°C. Parameters are measured at the antenna port.

Parameter	Condition/Notes	Min	Typ.	Max	Units
Sensitivity, Dirty TX off ^{(1), (2)}	BR (1 Mbps), 339 bytes, DH5 Packet, BER= 0.1%	-	-90.5	-	dBm
	EDR2 (2 Mbps), 679 bytes, 2-DH5 Packet, BER= 0.01%	-	-91.5	-	dBm
	EDR3 (3 Mbps), 1020 bytes, 3-DH5 Packet, BER= 0.01%	-	-84.5	-	dBm
	LE (1 Mbps), 37 bytes, PER=30.8%	-	-92	-	dBm
	LE (2 Mbps), 37 bytes, PER=30.8%	-	-90	-	dBm
	LR (500 Kbps), 37 bytes, PER=30.8%	-	-99	-	dBm
	LR (125 Kbps), 37 bytes, PER=30.8%	-	-103	-	dBm
Maximum Input Level	BR, EDR2, EDR3, BER= 0.1%	-	-15	-	dBm
	LE 1Mbps, 2Mbps, PER=30.8%	-	-1	-	dBm
	LR 500kps, 125kbps, PER=30.8%	-	>10	-	dBm
C/I Performance	BR, co-channel, BER=0.1%	9	-	-	dB
	BR, adjacent +1/-1 MHz, BER=0.1%	-2	-	-	dB
	BR, adjacent +2/-2 MHz BER=0.1%	-19	-	-	dB

Parameter	Condition/Notes	Min	Typ.	Max	Units
	BR, adjacent $\geq \pm 3 $ MHz BER=0.1%	-19	-	-	dB
	BR, Image channel BER=0.1%	-11	-	-	dB
	BR, adjacent to Image channel BER=0.1%	-22	-	-	dB
	EDR2, co-channel BER=0.1%	11	-	-	dB
	EDR2, adjacent +1/-1 MHz BER=0.1%	-2	-	-	dB
	EDR2, adjacent +2/-2 MHz BER=0.1%	-17	-	-	dB
	EDR2, adjacent $\geq \pm 3 $ MHz BER=0.1%	-17	-	-	dB
	EDR2, Image channel BER=0.1%	-9	-	-	dB
	EDR2, adjacent to Image channel BER=0.1%	-22	-	-	dB
	EDR3, co-channel BER=0.1%	19	-	-	dB
	EDR3, adjacent +1/- MHz BER=0.1%	3	-	-	dB
	EDR3, adjacent +2/-2 MHz BER=0.1%	-12	-	-	dB
	EDR3, adjacent $\geq \pm 3 $ MHz BER=0.1%	-12	-	-	dB
	EDR3, Image channel BER=0.1%	-2	-	-	dB
	EDR3, adjacent to Image channel BER=0.1%	-15	-	-	dB
	LE 1Mbps, co-channel PER=30.8%	-	10	-	dB
	LE 1Mbps, adjacent +1 MHz PER=30.8%	-	1	-	dB
	LE 1Mbps, adjacent -1 MHz PER=30.8%	-	-2	-	dB
	LE 1Mbps, adjacent +2 MHz PER=30.8%	-	-23	-	dB
	LE 1Mbps, adjacent -2 MHz PER=30.8%	-	-24	-	dB
	LE 1Mbps, adjacent +3 MHz PER=30.8%	-	-21	-	dB
	LE 1Mbps, adjacent -3 MHz PER=30.8%	-	-27	-	dB
	LE 1Mbps, adjacent $\geq \pm 4 $ MHz PER=30.8%	-	-35	-	dB
	LE 1Mbps, Image channel PER=30.8%	-	-24	-	dB

Parameter	Condition/Notes	Min	Typ.	Max	Units
	LE 1Mbps, +1MHz adjacent to Image channel PER=30.8%	-	-34	-	dB
	LE 1Mbps, -1MHz adjacent to Image channel PER=30.8%	-	-21	-	dB
	LE 2Mbps, co-channel PER=30.8%	-	11	-	dB
	LE 2Mbps, adjacent +2 MHz PER=30.8%	-	-4	-	dB
	LE 2Mbps, adjacent -2 MHz PER=30.8%	-	-4	-	dB
	LE 2Mbps, adjacent +4 MHz PER=30.8%	-	-13	-	dB
	LE 2Mbps, adjacent -4 MHz PER=30.8%	-	-17	-	dB
	LE 2Mbps, adjacent $\geq \pm 6 $ MHz PER=30.8%	-	-32	-	dB
	LE 2Mbps, Image channel PER=30.8%	-	-13	-	dB
	LE 2Mbps, +2MHz adjacent to Image channel PER=30.8%	-	-24	-	dB
	LE 2Mbps, -2MHz adjacent to Image channel PER=30.8%	-	-4	-	dB

Table 32. Bluetooth Receiver Characteristics on HP RF Chain

- BR, EDR:** Receiver sensitivity is degraded by up to 6 dB for channels 38,78 due to the desensitization of the receiver from harmonics of the system clock (40MHz)
- BLE, LR:** Receiver sensitivity is degraded by up to 8 dB for channels 19,29,30,39 due to the desensitization of the receiver from harmonics of the system clock (40MHz)
- There may be a degradation of up to 2 dB across the operating temperature range of -40 °C to +85 °C.

3.5.7 Bluetooth Receiver Characteristics on Low-Power (LP) RF Chain

TA = 25°C. Parameters are measured at the antenna port.

Parameter	Condition/Notes	Min	Typ.	Max	Units
Sensitivity, Dirty TX off ^{(1), (2)}	BR (1 Mbps), 339 bytes, DH5 Packet BER= 0.1%	-	-86	-	dBm
	EDR2 (2 Mbps), 679 bytes, 2-DH5 Packet, BER= 0.01%	-	-87	-	dBm
	LE (1 Mbps), 37 bytes, PER=30.8%	-	-89	-	dBm
	LE (2 Mbps), 37 bytes, PER=30.8%	-	-87	-	dBm

Parameter	Condition/Notes	Min	Typ.	Max	Units
	LR (500 Kbps), 37 bytes, PER=30.8%	-	-96.5	-	dBm
	LR (125 Kbps), 37 bytes, PER=30.8%	-	-101	-	dBm
Maximum Input Level	BR, EDR2 BER= 0.1%	-	-16	-	dBm
	LE 1Mbps, 2Mbps PER=30.8%	-	1	-	dBm
	LR 500kps, 125kbps PER=30.8%	-	>10	-	dBm
BER Floor		-	1e-4	-	%
C/I Performance	BR, co-channel BER= 0.1%	9	-	-	dB
	BR, adjacent +1/-1 MHz, BER=0.1%	-2	-	-	dB
	BR, adjacent +2/-2 MHz BER=0.1%	-19	-	-	dB
	BR, adjacent $\geq \pm 3 $ MHz BER=0.1%	-19	-	-	dB
	BR, Image channel BER=0.1%	-11	-	-	dB
	BR, adjacent to Image channel BER=0.1%	-22	-	-	dB
	EDR2, co-channel BER=0.1%	11	-	-	dB
	EDR2, adjacent +1/-1 MHz BER=0.1%	-2	-	-	dB
	EDR2, adjacent +2/-2 MHz BER=0.1%	-17	-	-	dB
	EDR2, adjacent $\geq \pm 3 $ MHz BER=0.1%	-17	-	-	dB
	EDR2, Image channel BER=0.1%	-9	-	-	dB
	EDR2, adjacent to Image channel BER=0.1%	-22	-	-	dB
	LE 1Mbps, co-channel PER=30.8%	-	10	-	dB
	LE 1Mbps, adjacent +1 MHz PER=30.8%	-	1	-	dB
	LE 1Mbps, adjacent -1 MHz PER=30.8%	-	-1	-	dB
	LE 1Mbps, adjacent +2 MHz PER=30.8%	-	-23	-	dB
	LE 1Mbps, adjacent -2 MHz PER=30.8%	-	-23	-	dB
	LE 1Mbps, adjacent +3 MHz PER=30.8%	-	-22	-	dB
	LE 1Mbps, adjacent -3 MHz PER=30.8%	-	-27	-	dB

Parameter	Condition/Notes	Min	Typ.	Max	Units
	LE 1Mbps, adjacent $\geq \pm 4 $ MHz PER=30.8%	-	-33	-	dB
	LE 1Mbps, Image channel PER=30.8%	-	-27	-	dB
	LE 1Mbps, +1MHz adjacent to Image channel PER=30.8%	-	-35	-	dB
	LE 1Mbps, -1MHz adjacent to Image channel PER=30.8%	-	-22	-	dB
	LE 2Mbps, co-channel PER=30.8%	-	10	-	dB
	LE 2Mbps, adjacent +2 MHz PER=30.8%	-	-5	-	dB
	LE 2Mbps, adjacent -2 MHz PER=30.8%	-	-3	-	dB
	LE 2Mbps, adjacent +4 MHz PER=30.8%	-	-12	-	dB
	LE 2Mbps, adjacent -4 MHz PER=30.8%	-	-18	-	dB
	LE 2Mbps, adjacent $\geq \pm 6 $ MHz PER=30.8%	-	-35	-	dB
	LE 2Mbps, Image channel PER=30.8%	-	-12	-	dB
	LE 2Mbps, +2MHz adjacent to Image channel PER=30.8%	-	-24	-	dB
	LE 2Mbps, -2MHz adjacent to Image channel PER=30.8%	-	-5	-	dB

Table 33. Bluetooth Receiver Characteristics on LP RF Chain

- BR, EDR:** Receiver sensitivity is degraded by up to 6 dB for channels 38,78 due to the desensitization of the receiver from harmonics of the system clock (40MHz)
- BLE, LR:** Receiver sensitivity is degraded by up to 8 dB for channels 19,29,30,39 due to the desensitization of the receiver from harmonics of the system clock (40MHz)
- There may be a degradation of up to 2 dB across the operating temperature range of -40 °C to +85 °C.

3.5.8 WLAN 5GHz Transmitter Characteristics

TA = 25 °C, Parameters are measured at antenna port on 3 channels and 3 frequency bands ⁽¹⁾

Parameter	Condition	Notes	Min	Typ.	Max	Units
Transmit Power for 20 MHz Bandwidth, compliant with IEEE mask and EVM	OFDM - 6 Mbps	EVM < -5 dB	-	11	-	dBm
	OFDM - 9 Mbps	EVM < -8 dB	-	10.5	-	dBm
Frequency Band: 5180 - 5300 MHz	OFDM - 12 Mbps	EVM < -10 dB	-	11	-	dBm

Parameter	Condition	Notes	Min	Typ.	Max	Units
	OFDM - 18 Mbps	EVM< -13 dB	-	11	-	dBm
	OFDM - 24 Mbps	EVM< -16 dB	-	11	-	dBm
	OFDM - 36 Mbps	EVM< -19 dB	-	10	-	dBm
	OFDM - 48 Mbps	EVM< -22 dB	-	8.5	-	dBm
	OFDM - 54 Mbps	EVM< -25 dB	-	7.5	-	dBm
	MCS0 Mixed Mode	EVM< -5 dB	-	11	-	dBm
	MCS1 Mixed Mode	EVM< -10 dB	-	11.5	-	dBm
	MCS2 Mixed Mode	EVM< -13 dB	-	11.5	-	dBm
	MCS3 Mixed Mode	EVM< -16 dB	-	10.5	-	dBm
	MCS4 Mixed Mode	EVM< -19 dB	-	9.5	-	dBm
	HT - MCS5	EVM< -22 dB	-	8	-	dBm
	HT - MCS6	EVM< -25 dB (See note section)	-	7	-	dBm
HT - MCS7	(See note section)	-	5	-	dBm	
Transmit Power for 20 MHz Bandwidth, compliant with IEEE mask and EVM Frequency Band: 5500 - 5600 MHz	OFDM - 6 Mbps	EVM< -5 dB	-	11	-	dBm
	OFDM - 9 Mbps	EVM< -8 dB	-	11.5	-	dBm
	OFDM - 12 Mbps	EVM< -10 dB	-	11.5	-	dBm
	OFDM - 18 Mbps	EVM< -13 dB	-	11.5	-	dBm
	OFDM - 24 Mbps	EVM< -16 dB	-	11.5	-	dBm
	OFDM - 36 Mbps	EVM< -19 dB	-	8.5	-	dBm
	OFDM - 48 Mbps	EVM< -22 dB	-	7	-	dBm
	OFDM - 54 Mbps	EVM< -25 dB	-	6.5	-	dBm
	MCS0 Mixed Mode	EVM< -5 dB	-	11.5	-	dBm
	MCS1 Mixed Mode	EVM< -10 dB	-	11.5	-	dBm

Parameter	Condition	Notes	Min	Typ.	Max	Units
	MCS2 Mixed Mode	EVM< -13 dB	-	11.5	-	dBm
	MCS3 Mixed Mode	EVM< -16 dB	-	10.5	-	dBm
	MCS4 Mixed Mode	EVM< -19 dB	-	8.5	-	dBm
	HT - MCS5	EVM< -22 dB	-	7	-	dBm
	HT - MCS6	EVM< -25 dB (See note section)	-	5	-	dBm
	HT - MCS7	(See note section)	-	4	-	dBm
Transmit Power for 20 MHz Bandwidth, compliant with IEEE mask and EVM Frequency Band: 5725 - 5825 MHz	OFDM - 6 Mbps	EVM< -5 dB	-	9	-	dBm
	OFDM - 9 Mbps	EVM< -8 dB	-	9	-	dBm
	OFDM - 12 Mbps	EVM< -10 dB	-	9	-	dBm
	OFDM - 18 Mbps	EVM< -13 dB	-	9	-	dBm
	OFDM - 24 Mbps	EVM< -16 dB	-	9.5	-	dBm
	OFDM - 36 Mbps	EVM< -19 dB	-	6.5	-	dBm
	OFDM - 48 Mbps	EVM< -22 dB	-	5	-	dBm
	OFDM - 54 Mbps	EVM< -25 dB	-	3.5	-	dBm
	MCS0 Mixed Mode	EVM< -5 dB	-	9	-	dBm
	MCS1 Mixed Mode	EVM< -10 dB	-	9.5	-	dBm
	MCS2 Mixed Mode	EVM< -13 dB	-	9.5	-	dBm
	MCS3 Mixed Mode	EVM< -16 dB	-	9.5	-	dBm
	MCS4 Mixed Mode	EVM< -19 dB	-	7	-	dBm
	HT - MCS5	EVM< -22 dB	-	5.5	-	dBm
	HT - MCS6	EVM< -25 dB (See note section)	-	3.5	-	dBm
	HT - MCS7	(See note section)	-	1	-	dBm
		776-794 MHz	CDMA2000	-	-159	-

Parameter	Condition	Notes	Min	Typ.	Max	Units
Transmitter Emissions (6 Mbps @ Maximum Power)	869–960 MHz	CDMAOne, GSM850	-	-159	-	dBm/Hz
	1450–1495 MHz	DAB	-	-158	-	dBm/Hz
	1570–1580 MHz	GPS	-	-158	-	dBm/Hz
	1710–1800 MHz	DSC-1800-Uplink	-	-158	-	dBm/Hz
	1805–1880 MHz	GSM 1800	-	-158	-	dBm/Hz
	1850–1910 MHz	GSM 1900	-	-158	-	dBm/Hz
	1910–1930 MHz	TDSCDMA, LTE	-	-158	-	dBm/Hz
	1930–1990 MHz	GSM1900, CDMAOne, WCDMA	-	-158	-	dBm/Hz
	2010–2075 MHz	TDSCDMA	-	-159	-	dBm/Hz
	2110–2170 MHz	WCDMA	-	-159	-	dBm/Hz
	2305–2370 MHz	LTE Band 40	-	-159	-	dBm/Hz
	2370–2400 MHz	LTE Band 40	-	-159	-	dBm/Hz
	2496–2530 MHz	LTE Band 41	-	-159	-	dBm/Hz
	2530–2560 MHz	LTE Band 41	-	-159	-	dBm/Hz
2570–2690 MHz	LTE Band 41	-	-155	-	dBm/Hz	

Table 34. WLAN 5 GHz Transmitter Characteristics

1. There is a variation of up to 3 dB in power across parts and channels.
2. The output power may degrade by up to 6 dB over the operating temperature range of -40 °C to +85 °C.
3. There may be a reduction in EVM of up to 1 dB in MCS6 data rate.
4. EVM for MCS7 data rate may not meet IEEE spec of -27dB.
5. IEEE spectral mask limits may be crossed in lower data rates in some channels, and if required power may be backed off by 1-2 dB.

3.5.9 WLAN 5GHz Receiver Characteristics

TA = 25 °C, Parameters are measured at antenna port on 3 channels and 3 frequency bands ⁽¹⁾

Parameter	Condition/Notes	Min	Typ.	Max	Units
Sensitivity for 20 MHz Bandwidth ⁽¹⁾ Frequency Band: 5180 - 5300 MHz	6 Mbps OFDM	-	-88	-	dBm
	9 Mbps OFDM	-	-87.5	-	dBm
	12 Mbps OFDM	-	-86.5	-	dBm
	18 Mbps OFDM	-	-84.5	-	dBm
	24 Mbps OFDM	-	-81.5	-	dBm

Parameter	Condition/Notes	Min	Typ.	Max	Units
	36 Mbps OFDM	-	-78	-	dBm
	48 Mbps OFDM	-	-74	-	dBm
	54 Mbps OFDM	-	-73	-	dBm
	MCS0 Mixed Mode	-	-86	-	dBm
	MCS1 Mixed Mode	-	-84.5	-	dBm
	MCS2 Mixed Mode	-	-82.5	-	dBm
	MCS3 Mixed Mode	-	-79.5	-	dBm
	MCS4 Mixed Mode	-	-75.5	-	dBm
	MCS5 Mixed Mode	-	-71.5	-	dBm
	MCS6 Mixed Mode	-	-68.5	-	dBm
	MCS7 Mixed Mode	-	-69	-	dBm
Sensitivity for 20 MHz Bandwidth (1) Frequency Band: 5500 - 5600 MHz	6 Mbps OFDM	-	-86.5	-	dBm
	9 Mbps OFDM	-	-86.5	-	dBm
	12 Mbps OFDM	-	-85.5	-	dBm
	18 Mbps OFDM	-	-83	-	dBm
	24 Mbps OFDM	-	-80.5	-	dBm
	36 Mbps OFDM	-	-76.5	-	dBm
	48 Mbps OFDM	-	-72.5	-	dBm
	54 Mbps OFDM	-	-70.5	-	dBm
	MCS0 Mixed Mode	-	-85	-	dBm
	MCS1 Mixed Mode	-	-83	-	dBm
	MCS2 Mixed Mode	-	-81	-	dBm
	MCS3 Mixed Mode	-	-78	-	dBm
	MCS4 Mixed Mode	-	-74.5	-	dBm
	MCS5 Mixed Mode	-	-70	-	dBm
	MCS6 Mixed Mode	-	-67	-	dBm
MCS7 Mixed Mode	-	-67.5	-	dBm	
Sensitivity for 20 MHz Bandwidth (1) Frequency Band: 5725 - 5825 MHz	6 Mbps OFDM	-	-85	-	dBm
	9 Mbps OFDM	-	-84	-	dBm
	12 Mbps OFDM	-	-83.5	-	dBm
	18 Mbps OFDM	-	-81	-	dBm
	24 Mbps OFDM	-	-78	-	dBm
	36 Mbps OFDM	-	-74.5	-	dBm
	48 Mbps OFDM	-	-70.5	-	dBm
	54 Mbps OFDM	-	-69	-	dBm

Parameter	Condition/Notes	Min	Typ.	Max	Units
	MCS0 Mixed Mode	-	-83	-	dBm
	MCS1 Mixed Mode	-	-81.5	-	dBm
	MCS2 Mixed Mode	-	-78.5	-	dBm
	MCS3 Mixed Mode	-	-76	-	dBm
	MCS4 Mixed Mode	-	-72.5	-	dBm
	MCS5 Mixed Mode	-	-68	-	dBm
	MCS6 Mixed Mode	-	-66	-	dBm
	MCS7 Mixed Mode	-	-66	-	dBm
Maximum Input Level for PER below 10%	802.11g	-	-11	-	dBm
	802.11n	-	-12	-	dBm
RSSI Accuracy Range		-3	-	-3	dB
Blocking level for 3 dB RX Sensitivity Degradation (Data rate 6Mbps OFDM, Desired signal at -79dBm)	776–794 MHz	-	-1	-	dBm
	824–849 MHz	-	-2	-	dBm
	880–915 MHz	-	-2	-	dBm
	1710–1785 MHz	-	-2	-	dBm
	1850–1910 MHz	-	-3	-	dBm
	1920–1980 MHz	-	-3	-	dBm
	2500–2570 MHz	-	-6	-	dBm
	2300–2400 MHz	-	-8	-	dBm
	2570–2620 MHz	-	-6	-	dBm
	2545–2575 MHz	-	-5	-	dBm
Return Loss		-10	-4.5	-	dB
Adjacent Channel Interference	6 Mbps OFDM	16	19	-	dB
	9 Mbps OFDM	15	18	-	dB
	12 Mbps OFDM	13	19	-	dB
	18 Mbps OFDM	11	18	-	dB
	24 Mbps OFDM	8	17	-	dB
	36 Mbps OFDM	4	20	-	dB
	48 Mbps OFDM	0	14	-	dB
	54 Mbps OFDM	-1	15	-	dB
	MCS7 Mixed Mode	-2	14	-	dB

Table 35. WLAN 5 GHz Receiver Characteristics

1. Receiver sensitivity may vary by up to 3 dB across parts and channels.

3.6 Typical Current Consumption

3.6.1 3.3 V

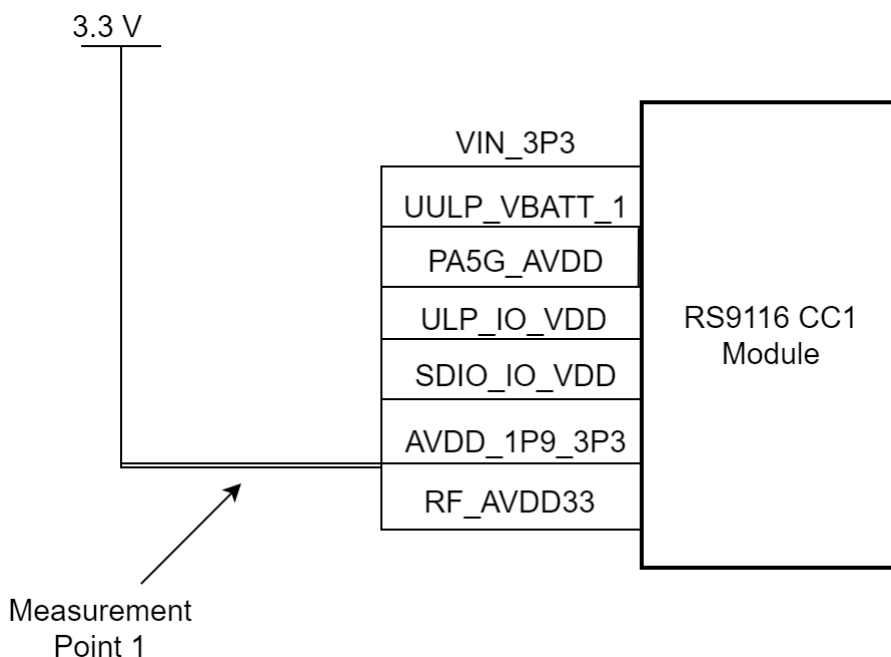

3.6.1.1 WLAN 2.4 GHz

Parameter	Description	Value	Units
1 Mbps Listen	LP Chain	13.8	mA
1 Mbps RX Active	LP Chain	19.6	mA
IEEE 802.11g – 6 Mbps RX Active	HP Chain	41	mA
IEEE 802.11g – 72 Mbps RX Active	HP Chain	42	mA
11 Mbps TX Active	Tx Power = Maximum (18dBm)	270	mA
	Tx Power = 8dBm	130	mA
IEEE 802.11g – 6 Mbps TX Active	Tx Power = Maximum (18dBm)	285	mA
	Tx Power = 8dBm	130	mA
IEEE 802.11g – 54 Mbps TX Active	Tx Power = Maximum (15dBm)	200	mA
	Tx Power = 8dBm	130	mA
IEEE 802.11g – 72 Mbps TX Active	Tx Power = Maximum (12dBm)	180	mA
	Tx Power = 8dBm	130	mA
Deep Sleep	GPIO Wake up	0.9	uA
Standby	State retained	13.1	uA
Standby Associated, DTIM = 1	2.4 GHz Band	586	uA
Standby Associated, DTIM = 3	2.4 GHz Band	238	uA
Standby Associated, DTIM = 10	2.4 GHz Band	102	uA

3.6.1.2 WLAN 5 GHz

Parameter	Description	Value	Units
IEEE 802.11a – 6 Mbps RX Active	HP Chain	133	mA
IEEE 802.11a – 72 Mbps RX Active	HP Chain	135	mA
IEEE 802.11a – 6 Mbps TX Active	Tx Power = Maximum (14 dBm)	313	mA
	Tx Power = 10 dBm	304	mA
Deep Sleep	Without RAM Retention	13	uA
Standby	State retained	19	uA
Standby Associated, DTIM = 1	5 GHz Band	1.1	mA
Standby Associated, DTIM = 3	5 GHz Band	670	uA
Standby Associated, DTIM = 10	5 GHz Band	265	uA

3.6.1.3 Bluetooth BR and EDR

Parameter	Description	Value	Units
TX Active Current, 1 Mbps BR	LP chain, Tx Power = -2 dBm	9.9	mA
	HP chain, Tx Power = Maximum (12 dBm)	130	mA
RX Active Current, 1 Mbps BR	LP chain	10.2	mA
	HP chain	26.7	mA
TX Active Current, 2 Mbps EDR	HP chain, Tx Power = Maximum (12 dBm)	130	mA
RX Active Current, 2 Mbps EDR	LP chain	10.2	mA
	HP chain	26.7	mA
TX Active Current, 3 Mbps EDR	HP chain, Tx Power = Maximum (12 dBm)	140	mA
RX Active Current, 3 Mbps EDR	HP chain	26.7	mA
Deep Sleep	GPIO Wake up	0.9	uA
Standby	State retained	13.1	uA

3.6.1.4 Bluetooth LE

Parameter	Description	Value	Units
TX Active Current	LP chain, Tx Power = -2 dBm	8.9	mA
	LP Chain, Tx Power = 2 dBm	-	mA
	HP Chain, Tx Power = Maximum (18 dBm)	190	mA
RX Active Current	LP chain	10.9	mA
	HP chain	26.7	mA
Deep Sleep	GPIO Wake up	0.9	uA
Standby	State retained	13.1	uA
Advertising, Unconnectable	Advertising on all 3 channels Advertising Interval = 1.28s Tx Power = -2 dBm, LP chain	45	uA

Parameter	Description	Value	Units
Advertising, Connectable	Advertising on all 3 channels Advertising Interval = 1.28s Tx Power = -2 dBm, LP chain	60	uA
Connected	Connection Interval = 1.28s No Data Tx Power = -2 dBm, LP chain	44	uA
Connected	Connection Interval = 200ms No Data Tx Power = 0 dBm, LP chain	144	uA

4 RS9116 CC1 Module Detailed Description

4.1 Overview

The RS9116 CC1 module is based on Silicon Labs' RS9116 ultra-low-power, single spatial stream, 802.11n + BT/BLE5.0 Convergence SOC. The RS9116 CC1 module is FCC, IC, CE and TELEC certified and provides low-cost CMOS integration of a multi-threaded MAC processor (ThreadArch®), baseband digital signal processing, analog front-end, calibration eFuse, 2.4GHz RF transceiver, 5GHz RF transceiver, matching networks, antenna, and Quad-SPI Flash thus providing a fully integrated solution for a range of hosted and embedded wireless applications. With Silicon Labs embedded four-threaded processor and on-chip ROM and RAM, these modules enable integration into low-cost and zero host load applications. With an integrated PMU and support for a variety of digital peripherals, RS9116 enables very low-cost implementations for wireless hosted and embedded applications. It can be connected to a host processor through SDIO, USB, USB-CDC, SPI or UART interfaces. Wireless firmware upgrades and provisioning are supported.

4.2 Module Features

4.2.1 WLAN

- Compliant to 1x1 IEEE 802.11 a/b/g/n with dual band (2.4 and 5 GHz) support
- Transmit power up to +18 dBm in 2.4 GHz and +13.5 dBm in 5 GHz
- Receive sensitivity as low as -96 dBm in 2.4 GHz and -89 dBm in 5 GHz
- Data Rates: 802.11b: Up to 11 Mbps; 802.11g/a: Up to 54 Mbps; 802.11n: MCS0 to MCS7
- Operating Frequency Range: 2412 MHz – 2484 MHz, 4.9 GHz – 5.975 GHz

4.2.1.1 MAC

- Conforms to IEEE 802.11b/g/n/j standards for MAC
- Dynamic selection of fragment threshold, data rate, and antenna depending on the channel statistics
- Hardware accelerators for WEP 64/128-bit and AES
- WPA, WPA2, and WMM support
- AMPDU and AMSDU aggregation for high performance
- Firmware downloaded from host based on application
- Hardware accelerators for DH (for WPS)

4.2.1.2 Baseband Processing

- Supports DSSS for 1, 2 Mbps and CCK for 5.5, 11 Mbps
- Supports all OFDM data rates (6, 9, 12, 18, 24, 36, 48, 54 Mbps, MCS0 to MCS7), and Short GI in Hosted mode
- Supports IEEE 802.11n single-stream modes with data rates up to 72 Mbps
- Supports long, short, and HT preamble modes
- High-performance multipath compensation in OFDM, DSSS, and CCK modes

4.2.2 Bluetooth

- Transmit power up to +18 dBm with integrated PA
- Receive sensitivity: LE: -93 dBm, LR 125 Kbps: -104 dBm
- Compliant to dual-mode Bluetooth 5
- <8 mA transmits current in Bluetooth 5 mode, 2 Mbps data rate
- Data rates: 125 Kbps, 500 Kbps, 1 Mbps, 2 Mbps, 3 Mbps

- Operating Frequency Range: 2.402 GHz - 2.480 GHz
- Bluetooth 2.1 + EDR, Bluetooth Low Energy 4.0 / 4.1 / 4.2 / 5.0
- Bluetooth Low Energy 1 Mbps, 2 Mbps and Long-Range modes
- Bluetooth Low Energy Secure connections
- Bluetooth Low Energy supports central role and peripheral role concurrently
- Bluetooth auto rate and auto TX power adaptation
- Scatternet* with two secondary roles while still being visible

* For a detailed list of software features and available profiles, refer to the Software Reference Manuals or contact Silicon Labs for availability.

4.2.2.1 MAC

4.2.2.1.1 Link Manager

- Creation, modification & release of logical links
- Connection establishment between Link managers of two Bluetooth devices
- Link supervision is implemented in Link Manager
- Link power control is done depending on the inputs from Link Controller
- Enabling & disabling of encryption & decryption on logical links
- Services the data transport requests from L2CAP and provides required QOS
- Support for security using ECDH hardware accelerator

4.2.2.1.2 Link Controller

- Encodes and decodes header of BT packets
- Manages flow control, acknowledgment, retransmission requests, etc.
- Stores the last packet status for all logical transports
- Chooses between SCO & ACL buffers depending on the control information coming from BBP resource manager
- Indicates the success status of packet transmission to upper layers
- Indicates the link quality to the LMP layer

4.2.2.1.3 Host Controller

- Receives & decodes commands received from the Bluetooth Host.
- Propagates the decoded commands to respective modules
- Responsible for transmitting and receiving packets from and to Host
- Formats the responses coming from other modules of Bluetooth Controller as events and sends them to the Host.

4.2.2.1.4 Device Manager

- Controls Scan & Connection processes
- Controls all BT Device operations except data transport operations
- Storing link keys
- BT Controller state transition management
- Slot synchronization & management
- Access contract management

- Scheduler

4.2.2.2 Baseband Processing

- Supports GFSK (1 Mbps), EDR-DQPSK, EDR-D8PSK
- Supports BLE and Bluetooth long range
- Supports Data rates up to 3 Mbps

4.2.3 RF Transceiver

- Integrated 2.4 GHz transceiver with highly programmable operating modes
- Integrated 5 GHz transceiver with highly programmable operating modes
- Integrated matching networks and diplexers
- Integrated antenna DPDT switch with optional antenna diversity
- Internal oscillator with 40 MHz crystal
- Inbuilt automatic boot up and periodic calibration enables ease of integration

4.2.4 Host Interfaces

- SDIO
 - Version 2.0-compatible
 - Supports SD-SPI, 1-bit, and 4-bit SDIO modes
 - Operation up to a maximum clock speed of 50 MHz
- SPI Interface
 - Operation up to a maximum clock speed of 100 MHz
- USB 2.0
 - Supports 480Mbps “High Speed” (HS), 12Mbps “Full Speed” (FS) and 1.5Mbps “Low Speed” (LS) serial data transmission
 - Support USB CDC and device mode
- UART
 - Supports variable baud rates between 9600 and 3686400 bps
 - AT command interface for configuration and data transmission/reception

NOTE: Hosted mode (n-Link) supports USB 2.0 and SDIO. Embedded Mode (WiSeConnect) supports SPI, USB CDC, SDIO, and UART.

4.2.4.1 Auto Host Detection

RS9116 detects the host interface automatically after connecting to respective host controllers like SDIO, SPI, UART, USB and USB-CDC. SDIO/SPI host interface is detected through the hardware packet exchanges. UART host interface is detected through the software based-on the received packets on the UART interface. USB-Device mode interface is detected through the hardware based-on VBUS signal level. The host interface detection between USB & USB-CDC will be taken care by the firmware based on the USB_CDC_DIS GPIO. This Host configuration is stored in always-on domain registers after detection (on power up) and reused this information at each wakeup.

4.2.5 Wireless Coexistence Manager

- Arbitration between Wi-Fi, Bluetooth, and Bluetooth Low Energy
- Application aware arbitration
- Adaptive frequency hopping (AFH) in Bluetooth is based on WLAN channel usage
- Pre inter thread interrupts generation for radio switching
- QoS assurance across different traffics

4.2.6 Software

The RS9116 software package supports 802.11 b/g/n Client, Access Point (Up to 16 clients), Concurrent Client and Access Point mode, Enterprise Security, dual-mode BT 5.0 functionality on a variety of host platforms and operating systems. The software package includes complete firmware, reference drivers, application profiles and configuration graphical user interface (GUI) for Linux operating systems. The Wi-Fi driver has support for a simultaneous access point, and client mode. Bluetooth host driver utilizes Opensource host stacks like BlueZ for Linux. The application layer supports all profiles supported by BlueZ on Linux. It has a wireless coexistence manager to arbitrate between protocols.

The RS9116 software package is available in two flavors

- **Hosted mode (n-Link™):** Wi-Fi stack, Bluetooth stack and profiles, and all network stacks reside on the host processor. Support for multiple Virtual Access Points available.
- **Embedded mode (WiSeConnect™):** Wi-Fi stack, TCP/IP stack, IP modules, Bluetooth stack and some profiles reside in RS9116; Some of the Bluetooth profiles reside in the host processor

NOTE: Please refer to the Software Manuals (TRM and PRM) in [RS9116 Document Library](#) for more details.

4.2.6.1 Hosted Mode (n-Link™)

- Available host interfaces: SDIO 2.0 and USB HS
- Support for 20 MHz channel bandwidth
- Application data throughput up to 50 Mbps (Hosted Mode) in 802.11n with 20 MHz bandwidth
- Host drivers for Linux
- Support for Client mode, Access point mode (Up to 16 clients), Concurrent Client and Access Point mode, and Enterprise Security
- Support for concurrent Wi-Fi, dual-mode Bluetooth 5

4.2.6.2 Embedded Mode (WiSeConnect™)

- Available host interface: UART, SPI, SDIO, and USB CDC
- Support for Embedded Client mode, Access Point mode (Up to 8 clients), Concurrent Client and Access Point mode, and Enterprise Security
- Supports advanced security features: WPA/WPA2-Personal and Enterprise
- Integrated TCP/IP stack, HTTP/HTTPS, SSL/TLS, MQTT
- Bluetooth inbuilt stack support for L2CAP, RFCOMM, SDP, SPP, GAP
- Bluetooth profile support for GAP, SDP, SPP, GATT, L2CAP, RFCOMM
- Wireless firmware update and provisioning
- Support for concurrent Wi-Fi, dual-mode Bluetooth 5

* For a detailed list of software features and available profiles, refer to the Software Reference Manuals or contact Silicon Labs for availability.

4.2.7 Security

RS9116 supports multiple levels of security capabilities available for the development of IoT devices.

- Accelerators: AES128/256 in Embedded Mode
- WPA2/WPA3 - Personal and WPA/WPA2 - Enterprise for Client*

* SW features depends on the firmware version. For a detailed list of software features and available profiles, refer to the Software Reference Manuals or contact Silicon Labs for availability.

4.2.8 Power Management

The RS9116 chipsets have an internal power management subsystem, including DC-DC converters and linear regulators. This subsystem generates all the voltages required by the chipset to operate from a wide variety of input sources.

- LC DC-DC switching converter for RF and Digital blocks
 - Wide input voltage range (3.0 to 3.6V) on pin VINBCKDC. VINBCKDC is an internal pin that is not terminated on the package, and it is not accessible.
 - Output - 1.4V and 300mA maximum load on pin VOUTBCKDC
- SC DC-DC - Switching converter for Always-ON core logic domain
 - Wide input voltage range (3.0 to 3.6V) on pin UULP_VBATT_1 and UULP_VBATT_2. UULP_VBATT_2 is an internal pin that is not terminated on the package, and it is not accessible.
 - Output - 1.05V
- LDO SOC - Linear regulator for digital blocks
 - Input - 1.4V from LC DC-DC or external regulated supply on pin VINLDOSOC. VINLDOSOC is an internal pin that is not terminated on the package, and it is not accessible.
 - Output - 1.15V and 300mA maximum load on pin VOUTLDOSOC
- LDO RF and AFE - Linear regulator for RF and AFE
 - Input - 1.4V from LC DC-DC or external regulated supply on pin RF_AVDD. RF_AVDD is an internal pin that is not terminated on the package, and it is not accessible.
 - Output - 1.1V and 20mA maximum load on pin VOUTLDOAFE
- LDO FLASH - Linear regulator for internal Flash
 - Input - Wide input voltage range (3.0 to 3.6V) on pin VINLDO1P8. VINLDO1P8 is an internal pin that is not terminated on the package, and it is not accessible.
 - Output - 1.8V and 20mA maximum load on pin VOUTLDO1P8

4.2.8.1 Output Voltage Ranges

Pin Description	Supply Voltage (V)	
	Min	Max
VOUTLDOSOC	1.05	1.21
VOUTLDO1P8	1.75	2.0
VOUTLDOAFE	1.0	1.21
UULP_VOUTSCDC	1.0	1.21
UULP_VOUTSCDC_RETN	0.715	1.21

Table 36. Min. and Max. specifications of various output voltages

The output voltages from the IC/module will be reflected as per specifications only after the firmware is loaded.

4.2.9 Low Power Modes

It supports Ultra-low power consumption with multiple power modes to reduce the system energy consumption.

- Dynamic Voltage and Frequency Scaling
- Low Power (LP) mode with only the host interface active
- Deep sleep (ULP) mode with only the sleep timer active – with and without RAM retention
- Wi-Fi standby associated mode with automatic periodic wake-up

- Automatic clock gating of the unused blocks or transit the system from Normal to LP or ULP modes

4.2.9.1 ULP Mode

In Ultra Low Power mode, the deep sleep manager has control over the other subsystems and processors and controls their active and sleep states. During deep sleep, the always-on logic domain operates on a lowered supply and a 32 kHz low-frequency clock to reduce power consumption. The ULP mode supports the following wake-up options:

- Timeout wakeup - Exit sleep state after programmed timeout value.
- GPIO Based Wakeup: Exit sleep state when GPIO goes High/Low based on programmed polarity.
- Analog Comparator Based wakeup - Exit sleep state on an event at the analog comparator.
- RTC Timer wakeup - Exit Sleep state on timeout of RTC timer
- WatchDog Interrupt based wakeup - Exit Sleep state upon watchdog interrupt timeout.

- ULP mode is not supported in the USB interface mode
- In Deep Sleep mode, all the power supply pins except VBATT can be powered-off.

4.2.9.2 LP Mode

In Low Power mode, Network processor maintains system state and gate all internal high frequency clocks. But host interface is ready to accept any command from host controller.

The LP mode supports the following wake-up options:

- Host Request - Exit sleep state on a command from HOST controller. whenever a command from the host is received, the processor serves the request with minimum latency and the clock is gated immediately after the completion of the operation to reduce power consumption
- GPIO based wakeup - Wakeup can be initiated through a GPIO pin
- Timeout wakeup - Exit sleep state after the programmed timeout value

4.2.10 Memory

4.2.10.1 On-chip Memory

The ThreadArch® processor has the following memory:

- On-chip 384Kbytes SRAM for the wireless stack.
- 512Kbytes of ROM which holds the Secure primary bootloader, Network Stack, Wireless stacks, and security functions.
- 16Kbytes of Instruction cache enabling eExecute In Place (XIP) with quad SPI flash memory.
- eFuse of 512 bytes (used to store primary boot configuration, security, and calibration parameters)

4.2.10.2 Serial Flash

The RS9116 utilizes a serial Flash to store processor instructions and other data. The SPI Flash Controller is a 1/2/4-wired interface for serial access of data from Flash. It can be used in either Single, Dual or Quad modes. Instructions are read using the Direct Fetch mode while data transfers use the Indirect Access mode. The SPI Flash Controller in RS9116 has been designed with programmable options for most of the single and multi-bit operations. RS9116 CC1 module has 4 Mbytes internal flash memory.

User cannot use Flash for application code, but certificates can be loaded. For more details about loading certificates, refer to following documents:

- [SAPI Reference Guide](#)
- [AT Command Reference Manual](#)

5 RS9116 CC1 Module Reference Schematics, BOM and Layout Guidelines

1. Customers should include provision for programming or updating the firmware at manufacturing.
2. If using UART, we recommend bringing out the SPI lines to test points, so designers could use the faster interface for programming the firmware as needed.
3. If using SPI as host interface, then firmware programming or update can be done through the host MCU, or if designer prefers to program standalone at manufacturing, then it is recommended to have test points on the SPI signals.
4. If SDIO/SPI/UART interface is not used, then their respective IO domains must still be connected to the power supply.
5. Refer to and follow AN1345 Hardware Design Checklist Application Note.

5.1 SDIO/SPI/UART

5.1.1 Schematics

The diagram below shows the typical schematic with SDIO/SPI/UART Host Interface.

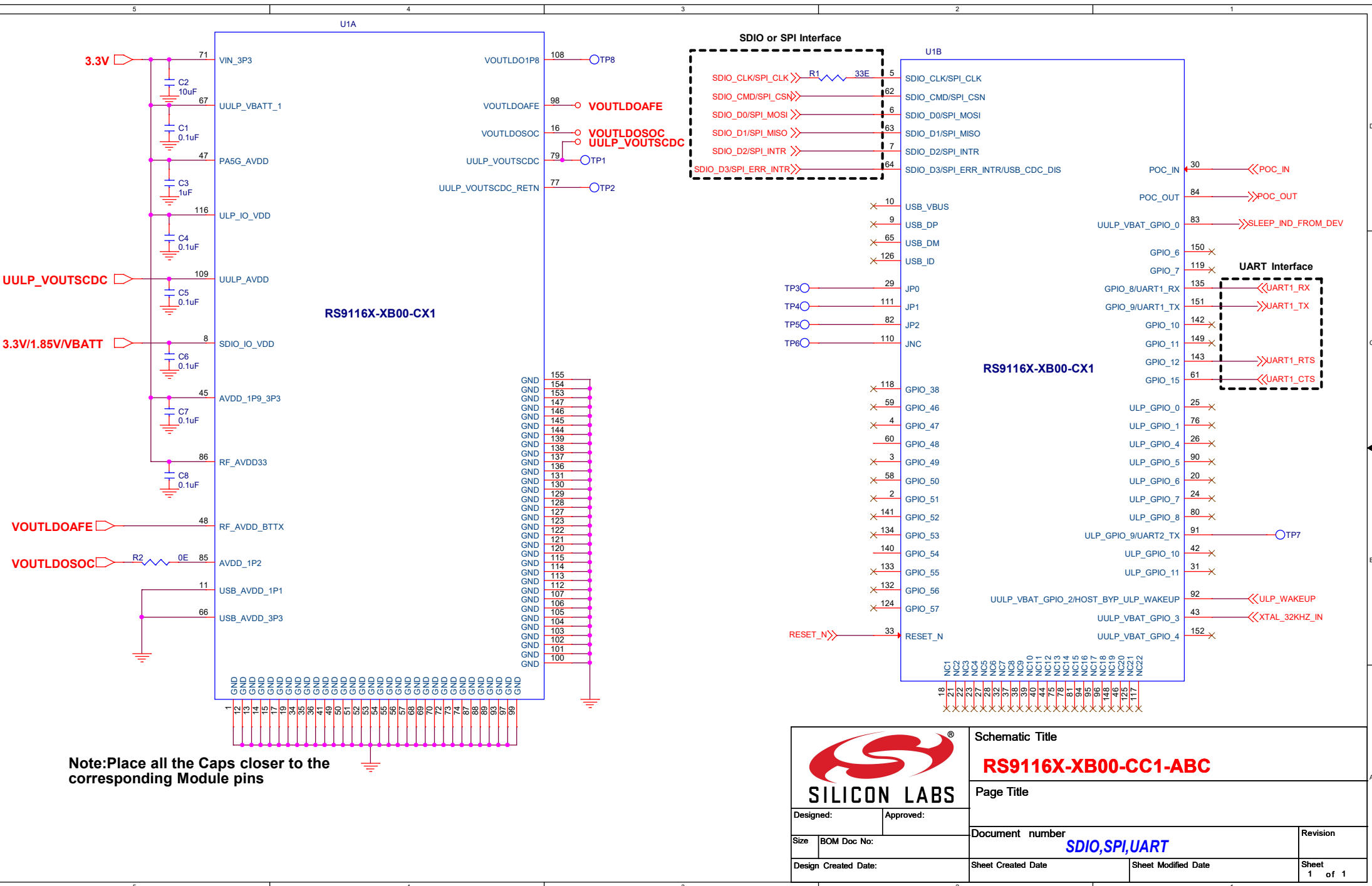

		Schematic Title	
		RS9116X-XB00-CC1-ABC	
Designed: _____ Approved: _____		Page Title	
Size	BOM Doc No:	Document number	Revision
Design Created Date:		SDIO, SPI, UART	
Sheet Created Date:		Sheet Modified Date	Sheet 1 of 1

Figure 16. Schematics with SDIO/SPI/UART Host Interface

1. The supplies can be driven by different voltage sources within the recommended operating conditions specified in Specifications section.
2. SDIO_IO_VDD can be driven by a different source irrespective of other sources to support different interfaces.
3. In the SDIO mode, pull-up resistors should be present on SDIO_CMD & SDIO Data lines as per the SDIO physical layer specification, version 2.0.
4. In SPI mode, ensure that the input signals, SPI_CS and SPI_CLK are not floating when the device is powered up and reset is deasserted. This can be done by ensuring that the host processor configures its signals (outputs) before deasserting the reset. SPI_INTR is the interrupt signal driven by the secondary device. This signal may be configured as Active-high or Active-low. If it is active-high, an external pull-down resistor is required. If it is active-low, an external pull-up resistor is required. The following action can be carried out by the host processor during power-up of the device, and before/after ULP Sleep mode.
 - a. To use the signal in the Active-high or Active-low mode, ensure that, during the power up of the device, the Interrupt is disabled in the Host processor before deasserting the reset. After deasserting the reset, the Interrupt needs to be enabled only after the SPI initialization is done and the Interrupt mode is programmed to either Active-high or Active-low mode as required.
 - b. The Host processor needs to be disabled the interrupt before the ULP Sleep mode is entered and enable it after SPI interface is reinitialized upon wakeup from ULP Sleep.
5. In UART mode, ensure that the input signals, UART_RX and UART_CTS are not floating when the device is powered up and reset is deasserted. This can be done by ensuring that the host processor configures its signals (outputs) before deasserting the reset.
6. Resistor "R1" should not be populated if UART is used as Host Interface.

5.1.2 Bill of Materials

S.No.	Quantity	Reference	Value	Description	JEDEC	Manufacturer	Part Number
1	1	C2	10uF	CAP CER 10UF 10V X5R 0805	0805	Murata	GRM21BR61A106KE19L
2	1	C3	1uF	CAP CER 1UF 10V 10% X5R 0402	0402	Murata	GRM155R61A105KE15D
3	6	C1, C4, C5, C6, C7, C8	0.1uF	CAP CER 0.1UF 10V X5R 0402	0402	Murata	GRM155R61A104KA01D
4	1	R1	33E	RES SMD 33 OHM 5% 1/10W	0402	Panasonic	ERJ-2GEJ330X
5	1	R2	0E	RES SMD 0 OHM JUMPER 1/16W 0402	0402	Yageo	RC0402JR-070RL
6	1	U1		Wireless Single/Dual Band Module		Silicon Labs	RS9116W-DB00-CC1-B2A / RS9116W-DB00-CC1-B2B / RS9116N-DB00-CC1-B00

Table 37 Bill of Materials with SDIO/SPI/UART Host Interface

5.2 USB/USB-CDC

5.2.1 Schematics

The diagram below shows the typical schematic with USB/USB-CDC Host Interface.

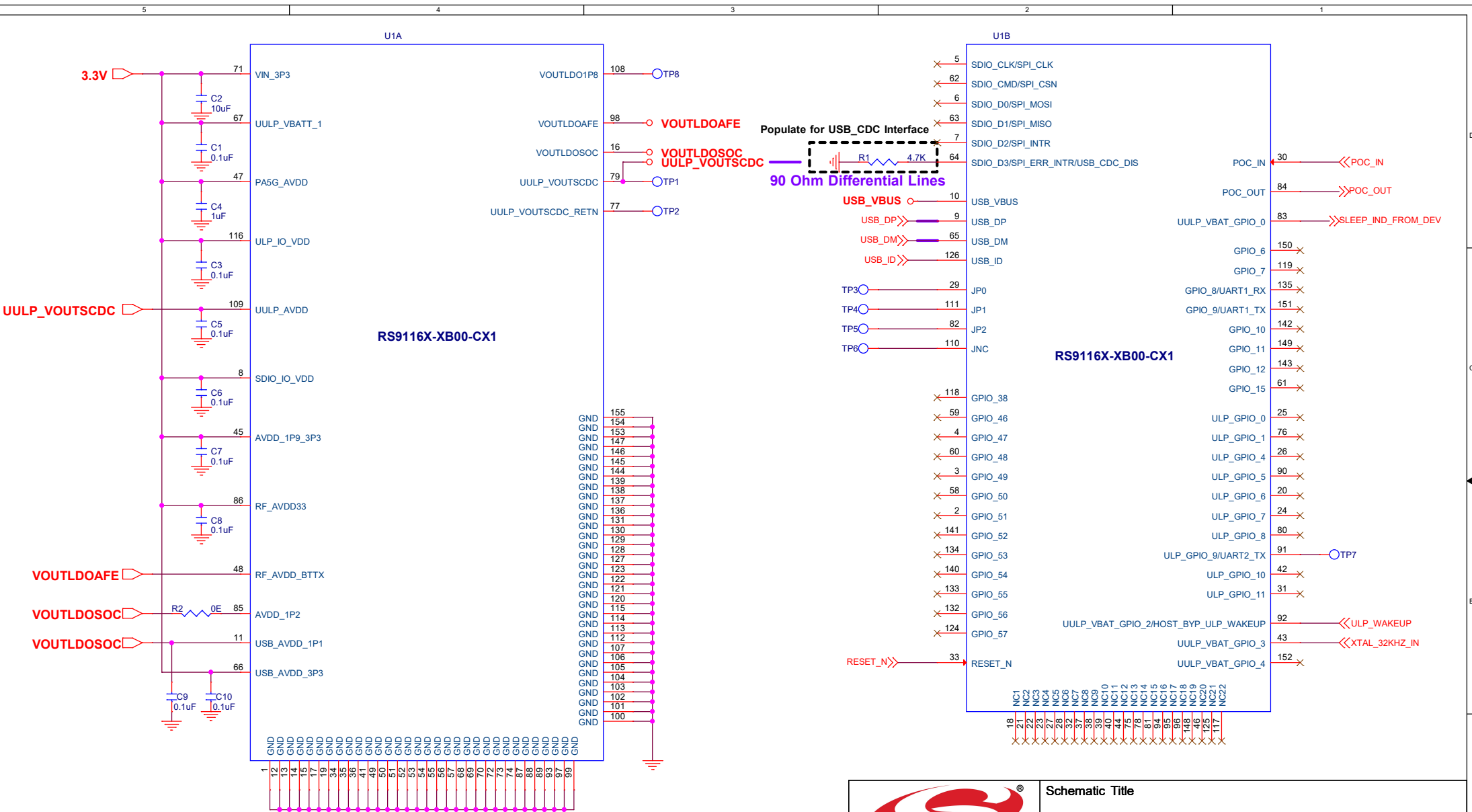

Note: Place all the Caps closer to the corresponding Module pins

		Schematic Title	
		RS9116X-XB00-CC1-ABC	
Designed: _____ Approved: _____		Page Title	
Size	BOM Doc No:	Document number	Revision
		USB,USB_CDC	
Design Created Date:	Sheet Created Date	Sheet Modified Date	Sheet 1 of 1

Figure 17. USB Schematics

1. The supplies can be driven by different voltage sources within the recommended operating conditions specified in Specifications section.
2. Ensure that the pin USB_CDC_DIS is left unconnected to ensure normal USB functionality.
3. Resistor "R1" should not be populated if normal USB is used as Host Interface.

5.2.2 Bill of Materials

S.No.	Quantity	Reference	Value	Description	JEDEC	Manufacturer	Part Number
1	1	C2	10uF	CAP CER 10UF 10V X5R 0805	0805	Murata	GRM21BR61A106KE19L
2	1	C4	1uF	CAP CER 1UF 10V 10% X5R 0402	0402	Murata	GRM155R61A105KE15D
3	8	C1, C3, C5, C6, C7, C8, C9, C10	0.1uF	CAP CER 0.1UF 10V X5R 0402	0402	Murata	GRM155R61A104KA01D
4	1	R1	4.7K	RES SMD 4.7K OHM 1% 1/16W 0402	0402	Yageo	RC0402FR-074K7L
5	1	R2	0E	RES SMD 0 OHM JUMPER 1/16W 0402	0402	Yageo	RC0402JR-070RL
6	1	U1		Wireless Single/Dual Band Module		Silicon Labs	RS9116W-DB00-CC1-B2A / RS9116W-DB00-CC1-B2B / RS9116N-DB00-CC1-B00

Table 38. Bill of Materials with USB/USB-CDC Host Interface

5.3 Layout Guidelines

The following guidelines outline the integration of the module: -

1. The following Supply Pins needs to be STAR routed from the Supply Source

1. VIN_3P3
2. UULP_VBATT_1
3. PA5G_AVDD
4. ULP_IO_VDD
5. SDIO_IO_VDD
6. AVDD_1P9_3P3
7. RF_AVDD33

2. There should be no metal planes or traces in the region under the PCB antenna and beside it for at least 3 mm. The module should be placed such that the antenna portion is on the edge of the PCB.

No metal planes or traces in the region under the PCB antenna and 3 mm beside it

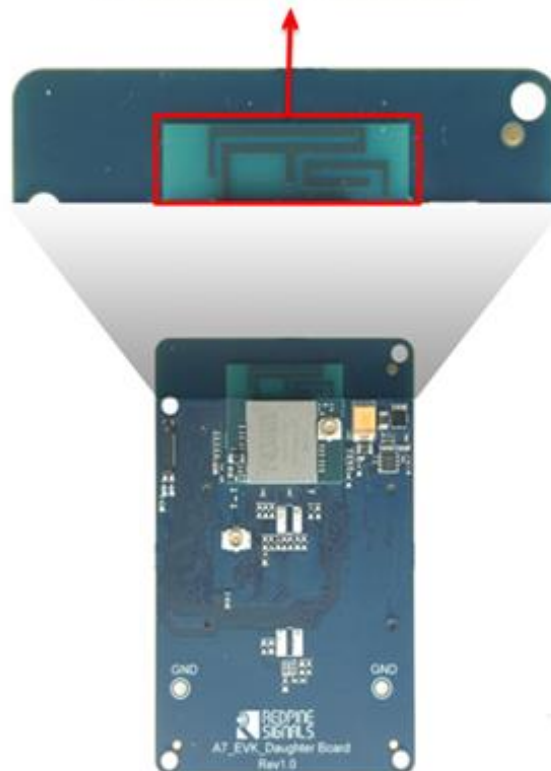

Figure 18. PCB Antenna Guidelines

3. For USB, it is recommended that the components and their values in the BoM be adhered to.

4. It is highly recommended that the two USB differential signals (USB_DP and USB_DN) be routed in parallel with a spacing (say, a) which achieves 90Ω of differential impedances, 45Ω for each trace.

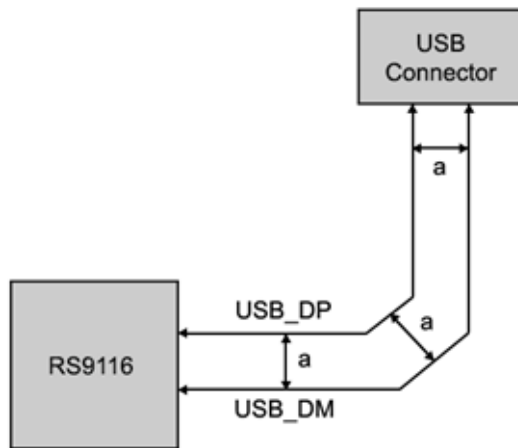

Figure 19. Spacing between USB_DP and USB_DM

5. In order to minimize crosstalk between the two USB differential signals (USB_DP and USB_DM) and other signal traces routed close to them, it is recommended that a minimum spacing of $3 \times a$ be maintained for low-speed non-periodic signals and a minimum spacing of $7 \times a$ be maintained for high-speed periodic signals.

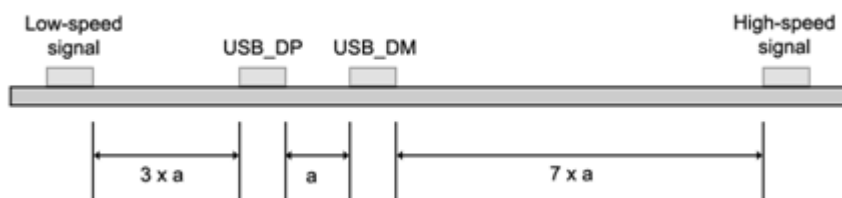

Figure 20. Spacing for Low-Speed and High-Speed Signals Around USB_DP/USB_DM

6. It is recommended that the total trace length of the signals between the RS9116 module and the USB connector be less than 450mm.

7. If the USB high-speed signals are routed on the Top layer, best results will be achieved if Layer2 is a Ground plane. Furthermore, there must be only one ground plane under high-speed signals in order to avoid the high-speed signals crossing to another ground plan

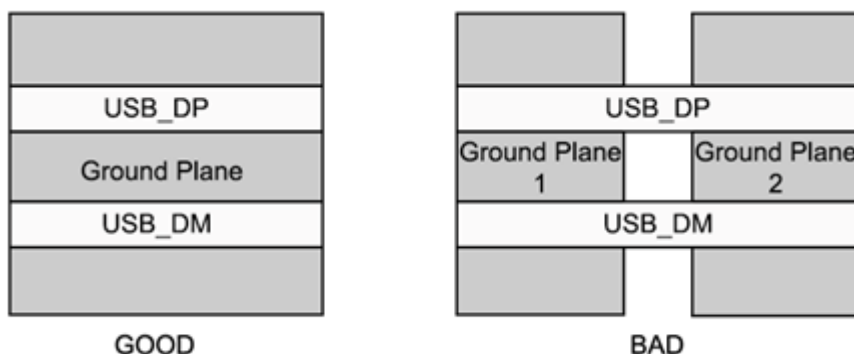

Figure 21. USB Signals and the Ground Plane

8. Each GND pin must have a separate GND via.

9. All decoupling capacitors placement must be as much close as possible to the corresponding power pins, and the trace lengths as short as possible.

- 10. Ensure all power supply traces widths are sufficient enough to carry corresponding currents.
- 11. Add GND copper pour underneath IC/Module in all layers, for better thermal dissipation.

The details of u.FL connector for external antenna :-

The module with integrated antenna comes with an option to connect an external antenna through a u.FL connector. The choice between the on-board antenna and the external antenna can be made through a software command. The figures below show the u.FL connector integrated on the module. The connector on the external antenna should be pushed down to fit into the u.FL connector connected to the module.

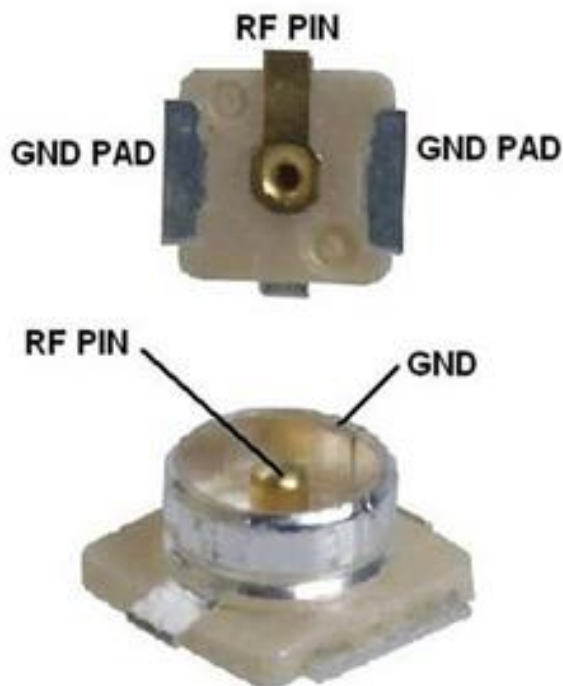
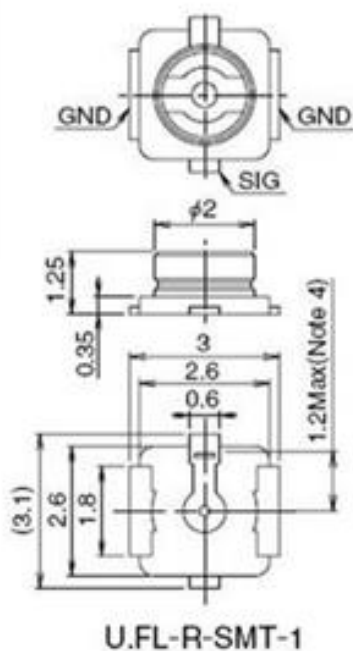

Figure 22. u.FL Connector (Part No: Hirose U.FL-R-SMT (01))



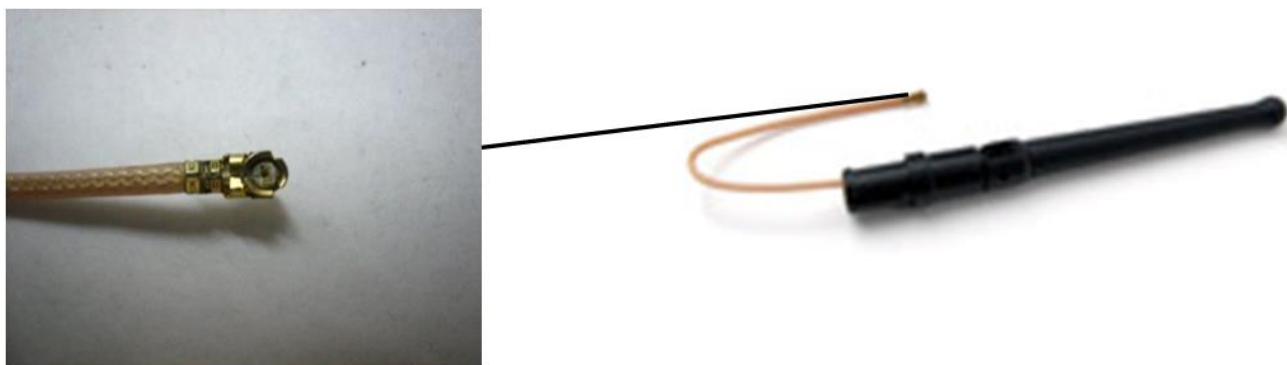

Figure 23. External Antenna

1. Refer to and follow AN1342 CC1 Board Layout Guidelines Application Note.

6 RS9116 CC1 Module Antenna Specifications

6.1 Overview

The sections that follow provide the performance specifications of the dual band PCB Antenna for 9116 M7DB/M7DB6 module used in FCC, IC, ETSI/CE and other regulatory certifications.

6.2 PCB Antenna Performance Specifications

6.2.1 Return Loss Characteristic of the Antenna

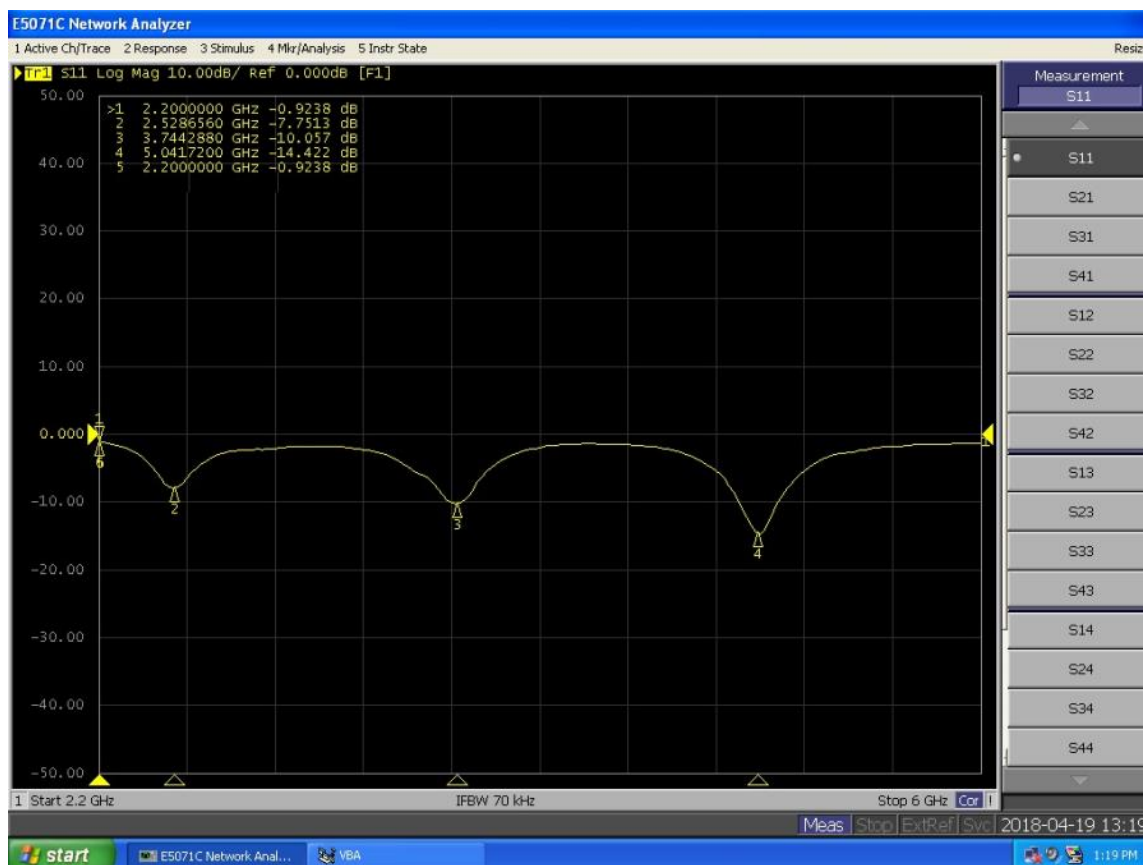

Figure 24. Return Loss Characteristic of the Antenna

6.2.2 Module Reference Orientation

Size of test board is 45 x 30 mm

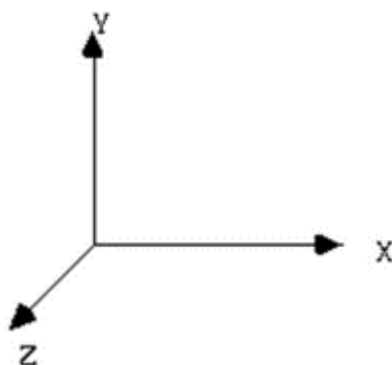

Figure 25. Module Reference Orientation



6.2.3 2D Gain Plots at 2.4 GHz

6.2.3.1 XY at 2.4 GHz

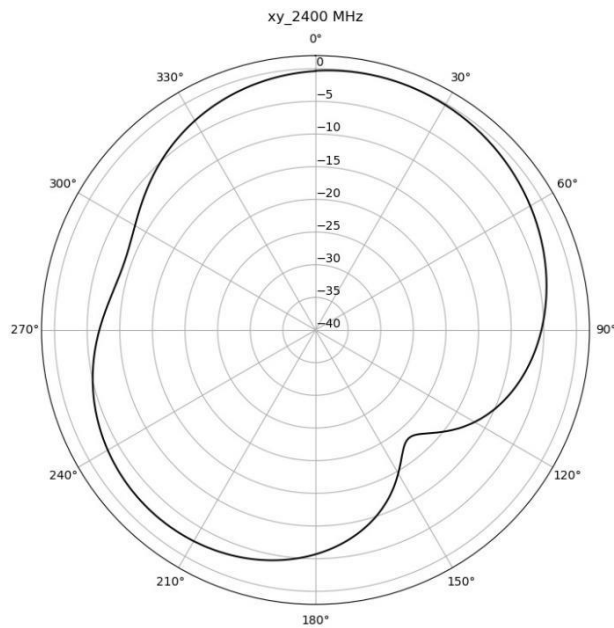

Figure 26. 2D Gain Plot for XY at 2.4 GHz

6.2.3.2 YZ at 2.4 GHz

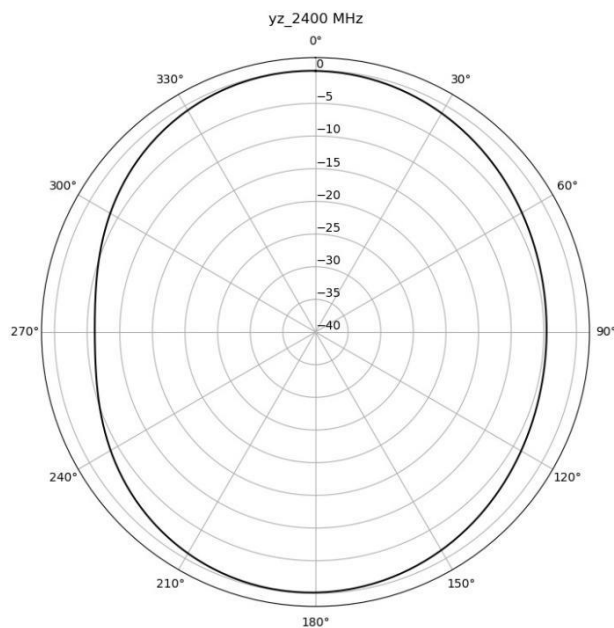

Figure 27. 2D Gain Plot for YZ at 2.4 GHz

6.2.3.3 ZX at 2.4 GHz

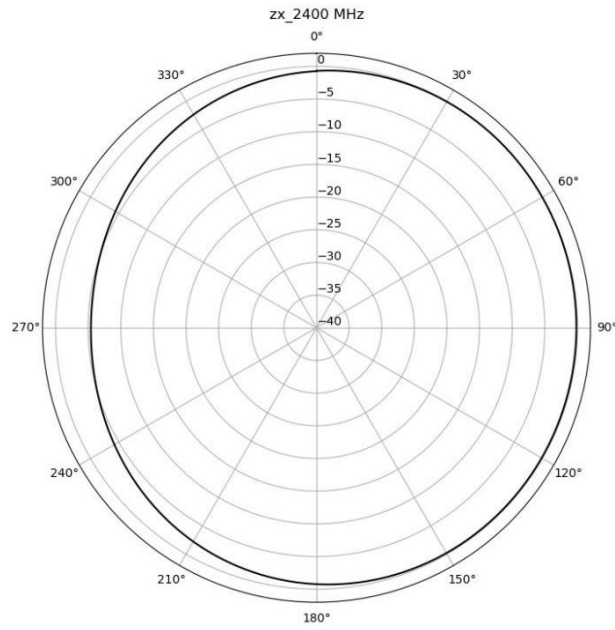

Figure 28. 2D Gain Plot at ZX at 2.4 GHz

6.2.4 2D Gain Plots at 2.430 GHz

6.2.4.1 XY at 2.43 GHz

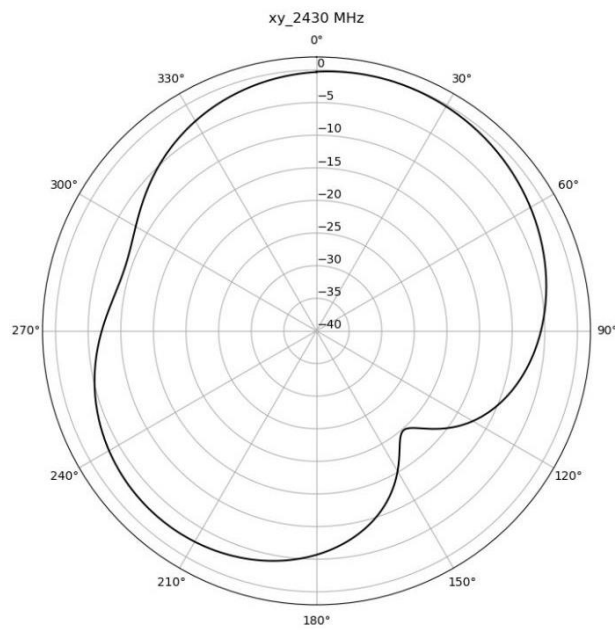

Figure 29. 2D Gain Plot for XY at 2.43 GHz

6.2.4.2 YZ at 2.43 GHz

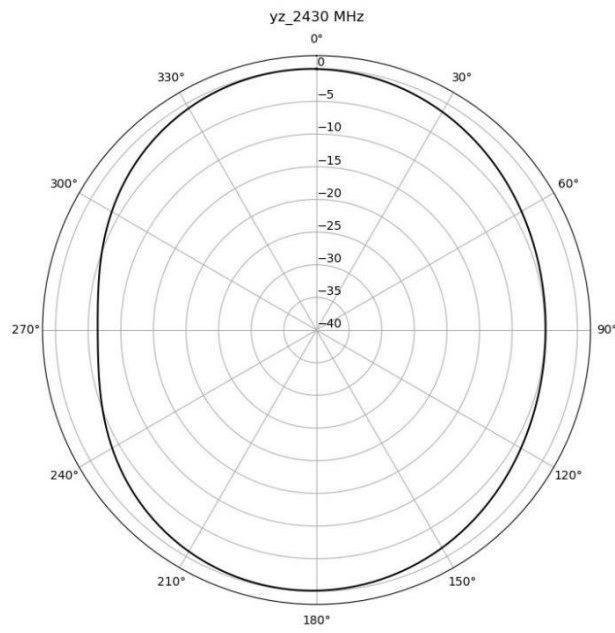

Figure 30. 2D Gain Plot for YZ at 2.43 GHz

6.2.4.3 ZX at 2.43 GHz

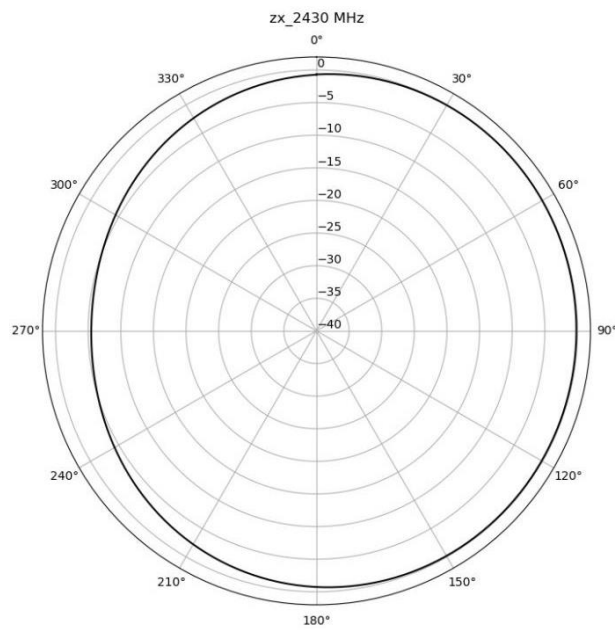

Figure 31. 2D Gain Plot for ZX at 2.43 GHz

6.2.5 2D Gain Plots at 2.480 GHz

6.2.5.1 XY at 2.484 GHz

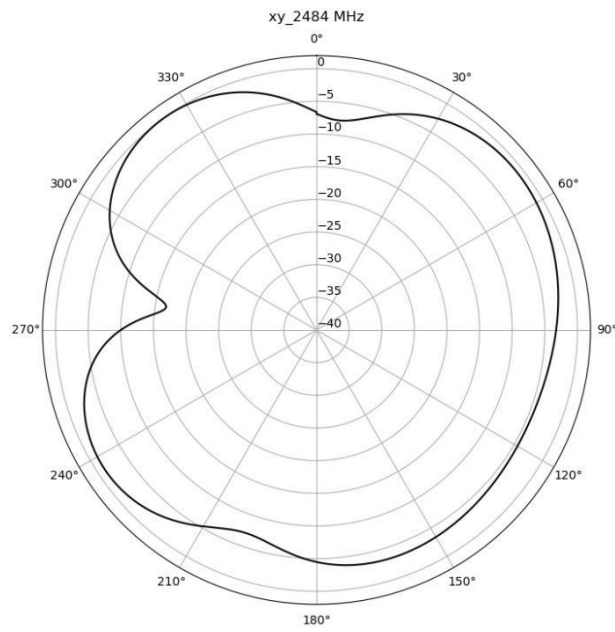

Figure 32. 2D Gain Plot for XY at 2.484 GHz

6.2.5.2 YZ at 2.484 GHz

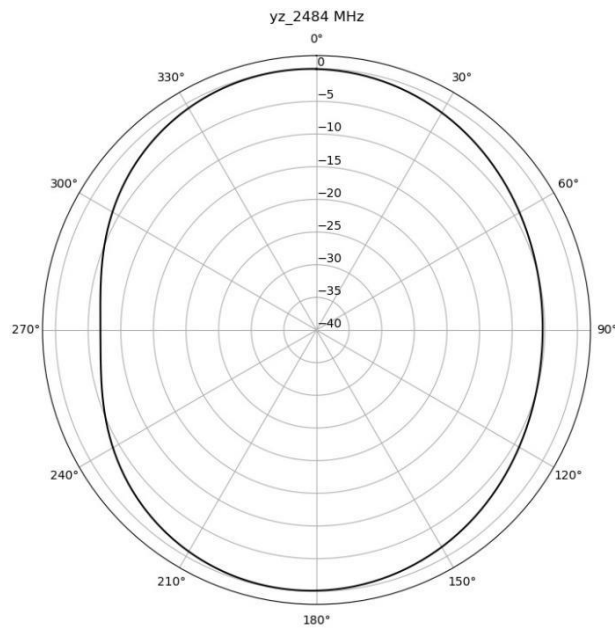

Figure 33. 2D Gain Plot for YZ at 2.484 GHz

6.2.5.3 ZX at 2.484 GHz

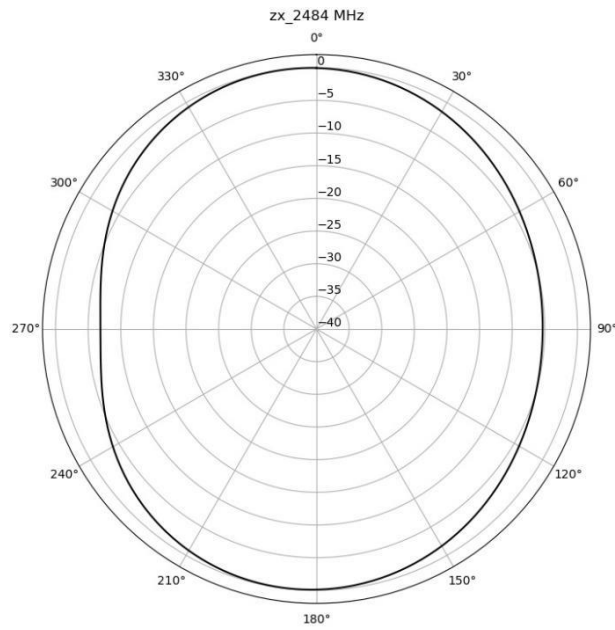

Figure 34. 2D Gain Plot for ZX at 2.484 GHz

6.2.6 2D Gain Plots at 5.1 GHz

6.2.6.1 XY at 5.1 GHz

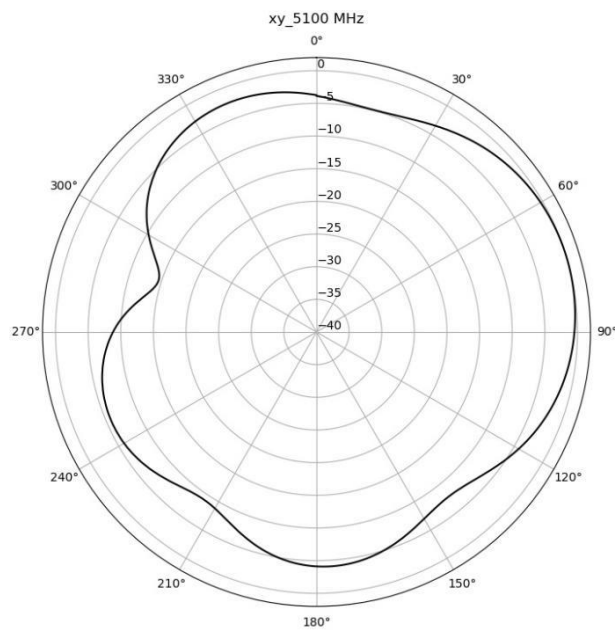

Figure 35. 2D Gain Plot for XY at 5.1 GHz

6.2.6.2 YZ at 5.1 GHz

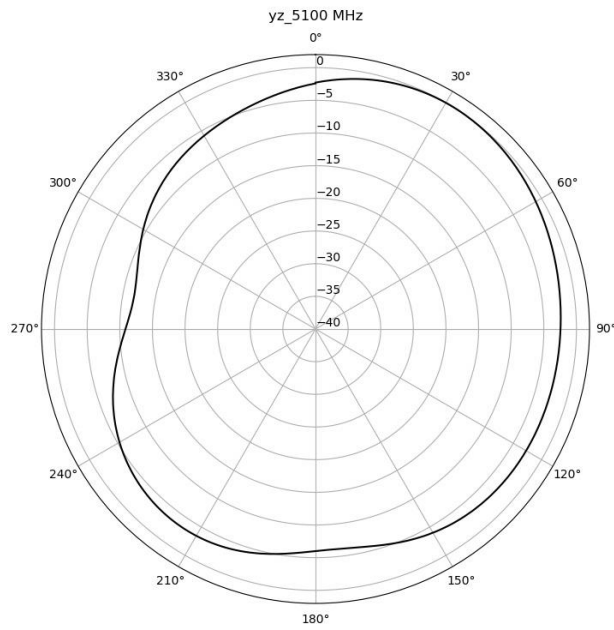

Figure 36. 2D Gain Plot for YZ at 5.1 GHz

6.2.6.3 ZX at 5.1 GHz

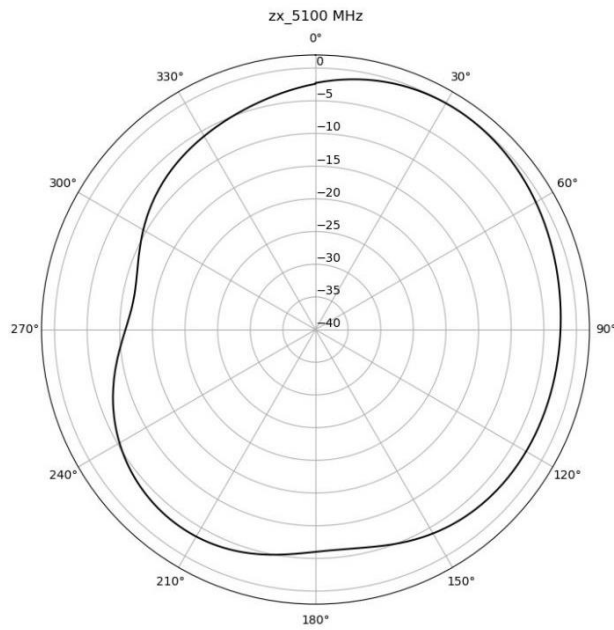

Figure 37. 2D Gain Plot for ZX at 5.1 GHz

6.2.7 2D Gain Plots at 5.5 GHz

6.2.7.1 XY at 5.5 GHz

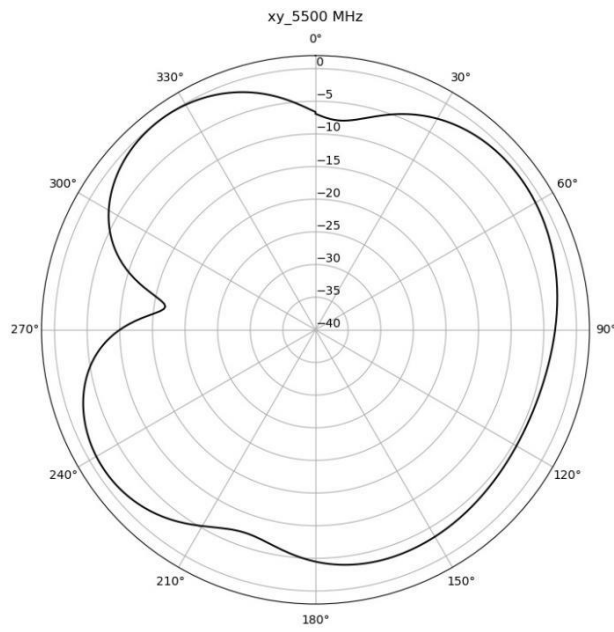

Figure 38. 2D Gain Plot for XY at 5.5 GHz

6.2.7.2 YZ at 5.5 GHz

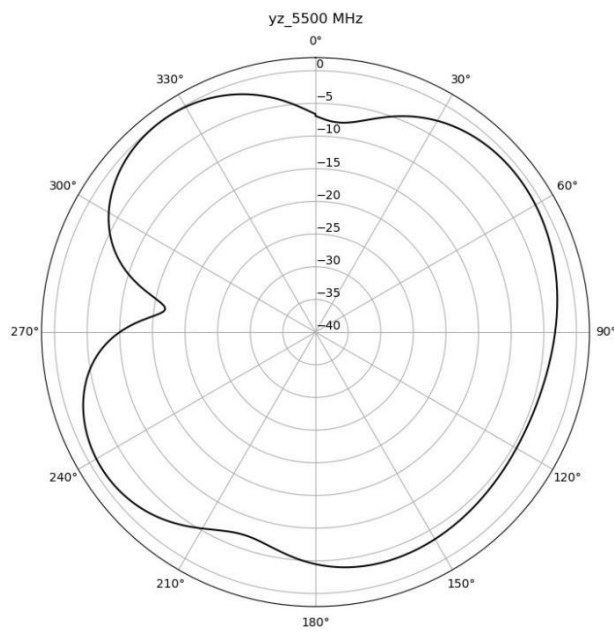

Figure 39. 2D Gain Plot for YZ at 5.5 GHz

6.2.7.3 ZX at 5.5 GHz

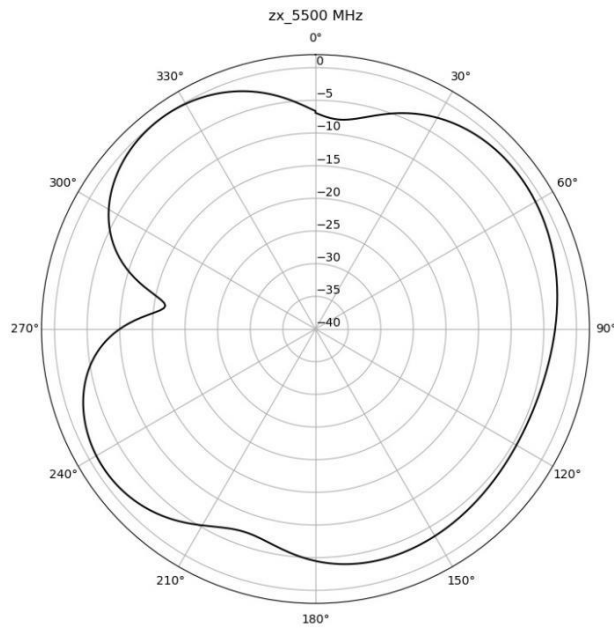

Figure 40. 2D Gain Plot for ZX at 5.5 GHz

6.2.8 2D Gain Plots at 5.9 GHz

6.2.8.1 XY at 5.9 GHz

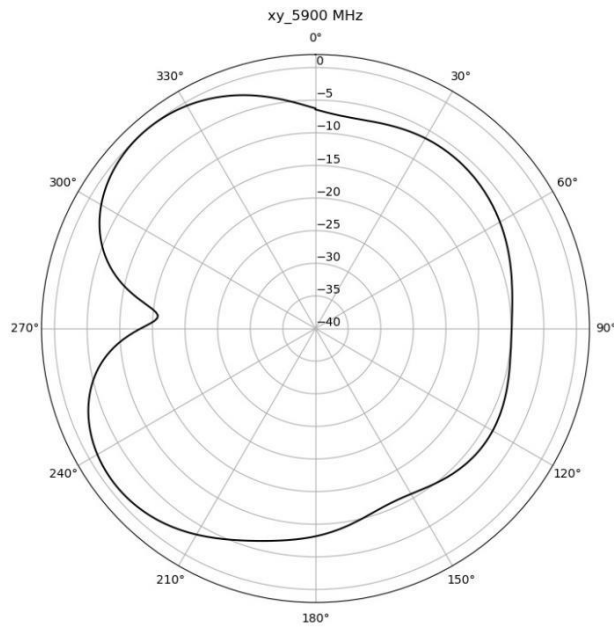

Figure 41. 2D Gain Plot for XY at 5.9 GHz

6.2.8.2 YZ at 5.750 GHz

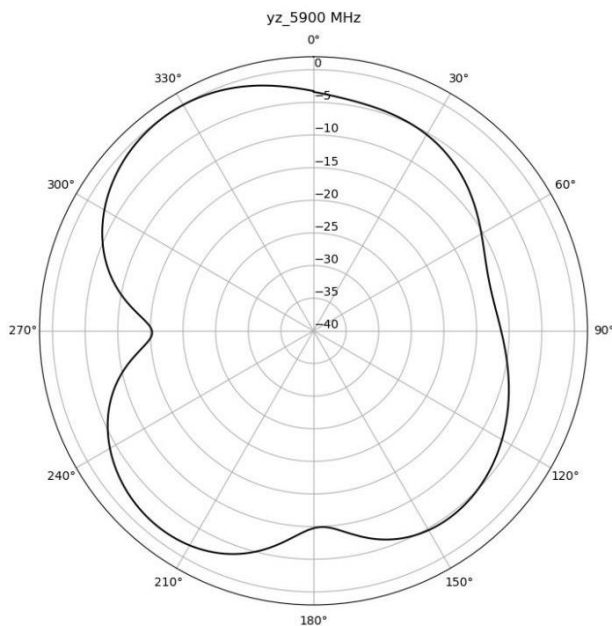

Figure 42. 2D Gain Plot for YZ at 5.9 GHz

6.2.8.3 ZX at 5.9 GHz

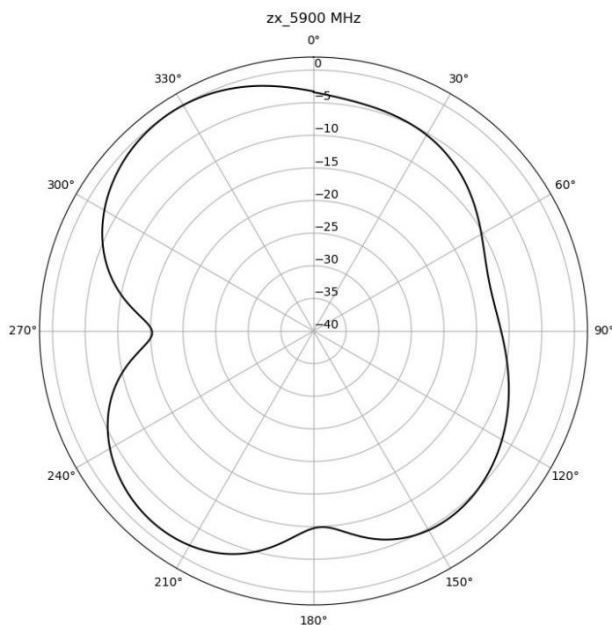

Figure 43. 2D Gain Plot for ZX at 5.9 GHz

6.3 Antenna Parameters

Parameter	2400 - 2500 MHz	5000 - 6000 MHz
Peak Gain	0.712 dBi	1.25 dBi

Table 39. Antenna Parameters

6.4 Mechanical Characteristics

Parameter	Value (L X W)	Units
Module PCB Dimensions	15 x 15.7	mm
Tolerance	±0.2	mm

Table 40. Mechanical Characteristics

7 RS9116 CC1 Module Package Description

7.1 Dimensions

Parameter	Value (L X W X H)	Units
Module Dimensions	15 x 15.7 x 2.2	mm
Tolerance	±0.2	mm

Table 41. Module Dimensions

7.1.1 Packing Information of Modules with Package Codes CC1

The modules are packaged and shipped in Trays.

Each tray for the CC1 package can accommodate 112 modules. The mechanical details of the tray for the CC1 package are given in the figure below.

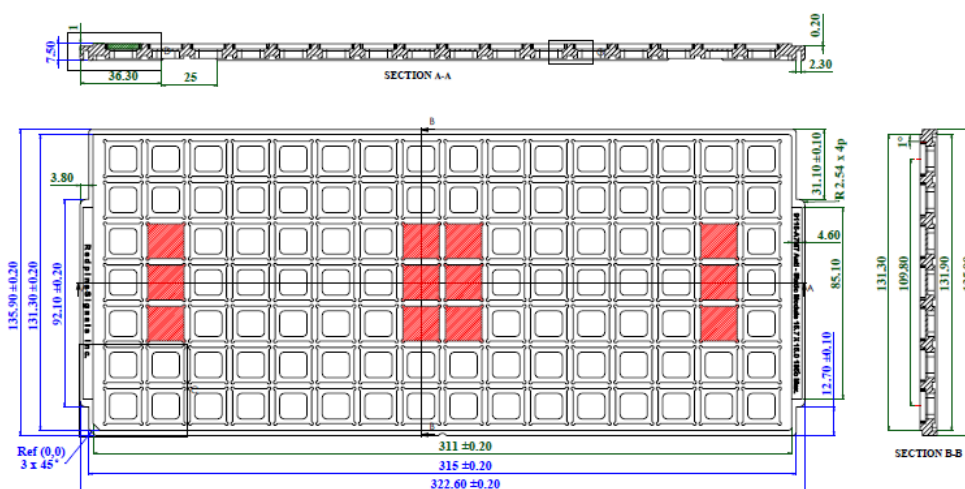
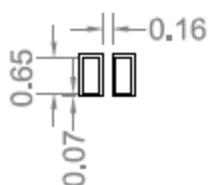
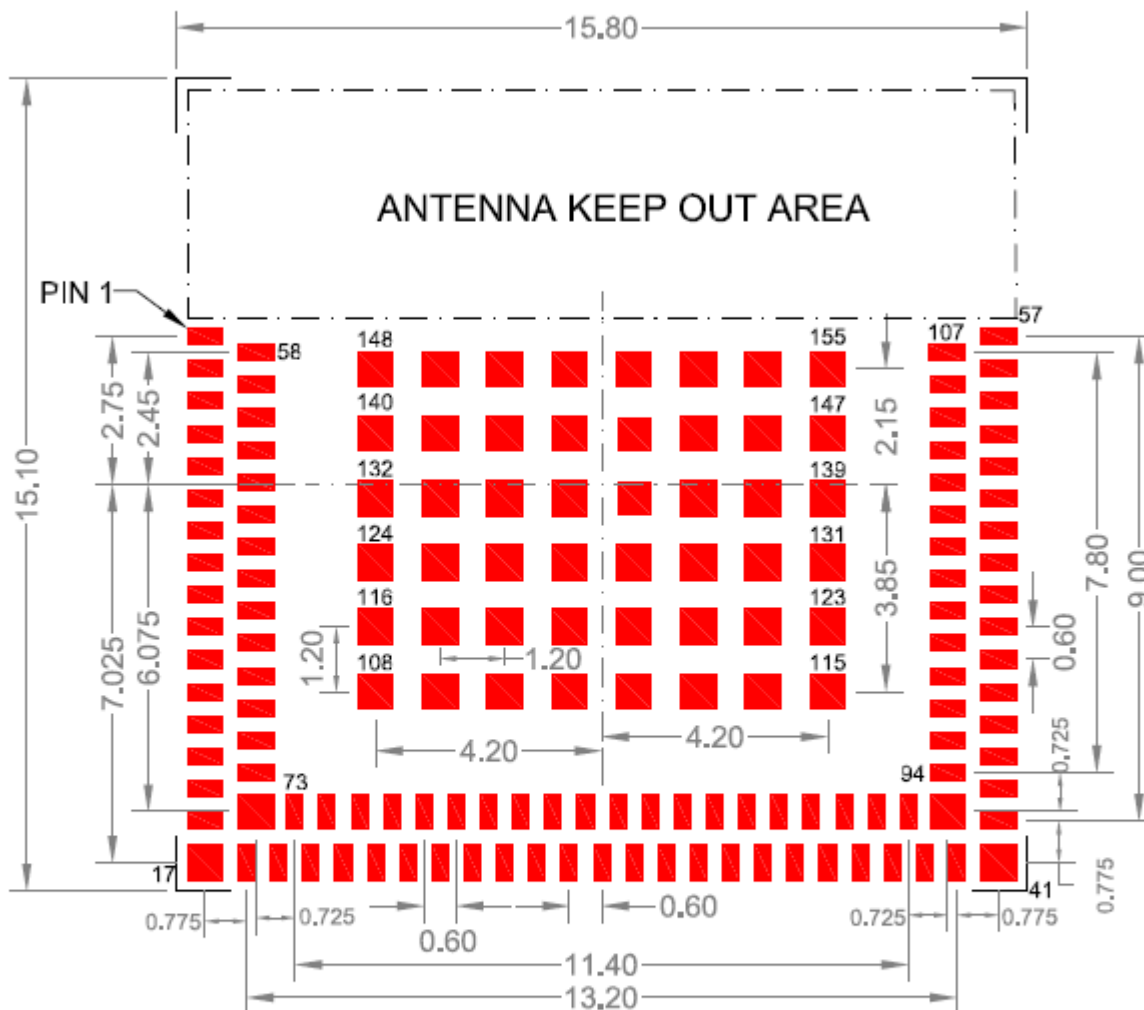

Figure 44. Packing Information of Modules with Package Codes CC1

7.3 PCB Landing Pattern

TOP VIEW



PAD SIZE 0.30mm x 0.65mm
 CORNERPAD SIZE 0.65mm x 0.65mm
 PAD PITCH:0.60mm
 ALL DIMENSIONS ARE IN : mm

8 RS9116 CC1 Module Certification and Ordering Information

8.1 Certification Information

This section will outline the regulatory certification information for the RS9116 modules for the countries listed below. This information will be updated when available.

1. United States
2. Canada
3. Europe
4. Japan
5. Other Regulatory Jurisdictions

The RS9116 Dual band CC1 module from Silicon Labs have undergone modular certification for FCC, IC, TELEC, and CE/ETSI (including EN 300 328 v2.2.2). Note that any changes to the module's configuration including (but not limited to) the programming values of the RF Transceiver and Baseband can cause the performance to change beyond the scope of the certification. These changes, if made, may result in the module having to be certified afresh. The table below lists the details of the regulatory certifications. The certification for geographies not listed in the table is in progress.

8.2 Compliance and Certification

M7DB6 and M7DB modules are FCC/IC/CE/MIC certified. This section outlines the regulatory information for the M7DB6/M7DB modules. This allows integrating the modules in an end product without the need to obtain subsequent and separate approvals from these regulatory agencies. This is valid in the case no other intentional or un-intentional radiator components are incorporated into the product and no change in the module circuitry. Without these certifications, an end product cannot be marketed in the relevant regions.

- RF Testing Software is provided for any end product certification requirements.

8.2.1 Federal Communication Commission Statement

Any changes or modifications not expressly approved by the party responsible for compliance could void your authority to operate the equipment.

Note

This equipment has been tested and found to comply with the limits for a Class B digital device, pursuant to part 15 of the FCC Rules. These limits are designed to provide reasonable protection against harmful interference in a residential installation.

This equipment generates, uses, and can radiate radio frequency energy and, if not installed and used in accordance with the instructions, may cause harmful interference to radio communications. However, there is no guarantee that interference will not occur in a particular installation.

If this equipment does cause harmful interference to radio or television reception, which can be determined by turning the equipment off and on, the user is encouraged to try to correct the interference by one or more of the following measures:

- Reorient or relocate the receiving antenna.
- Increase the separation between the equipment and receiver.
- Connect the equipment into an outlet on a circuit different from that to which the receiver is connected.
- Consult the dealer or an experienced radio/TV technician for help.

8.2.1.1 RF exposure statements

1. This Transmitter must not be co-located or operating in conjunction with any other antenna or transmitter.

2. This equipment complies with FCC RF radiation exposure limits set forth for an uncontrolled environment. This equipment should be installed and operated with a minimum distance of 20 centimeters between the radiator and your body or nearby persons.

For a host using a certified modular with a standard fixed label, if (1) the module's FCC ID is not visible when installed in the host, or (2) if the host is marketed so that end users do not have straightforward commonly used methods for access to remove the module so that the FCC ID of the module is visible; then an additional permanent label referring to the enclosed module should be used. For M7DB6 module, "Contains Transmitter Module FCC ID: XF6-M7DB6" or "Contains FCC ID: XF6-M7DB6" must be used; for M7DB module, "Contains Transmitter Module FCC ID: XF6-M7DB7" or "Contains FCC ID: XF6-M7DB7" must be used. The host OEM user manual must also contain clear instructions on how end users can find and/or access the module and the FCC ID.

8.2.1.2 Labeling and User Information

This device complies with part 15 of the FCC Rules. Operation is subject to the following two conditions:

1. This device may not cause harmful interference, and
2. this device must accept any interference received, including interference that may cause undesired operation.

8.2.2 Industry Canada / ISED Statement

This product meets the applicable Innovation, Science and Economic Development Canada technical specifications. Ce produit répond aux spécifications techniques applicables à l'innovation, Science et Développement économique Canada.

8.2.2.1 Radiation Exposure Statement

This equipment complies with IC radiation exposure limits set forth for an uncontrolled environment. This equipment should be installed and operated with minimum distance 20cm between the radiator & your body.

Cet équipement est conforme aux limites d'exposition aux rayonnements IC établies pour un environnement non contrôlé. Cet équipement doit être installé et utilisé avec un minimum de 20 cm de distance entre la source de rayonnement et votre corps.

This device complies with Industry Canada license-exempt RSSs. Operation is subject to the following two conditions:

1. This device may not cause interference, and
2. This device must accept any interference, including interference that may cause undesired operation of the device.

Le présent appareil est conforme aux CNR d'Industrie Canada applicables aux appareils radio exempts de licence. L'exploitation est autorisée aux deux conditions suivantes:

1. l'appareil ne doit pas produire de brouillage;
2. l'utilisateur de l'appareil doit accepter tout brouillage radioélectrique subi, même si le brouillage est susceptible d'en compromettre le fonctionnement.

8.2.2.2 Labeling and User Information

Innovation, Science and Economic Development Canada ICES003 Compliance Label: CAN ICES-3 (B)/NMB-3(B)

The M7DB6 and M7DB modules have been labeled with its own IC ID number (8407A-M7DB6 and 8047A-M7DB7) and if the IC ID is not visible when the module is installed inside another device, then the outside of the finished product into which the module is installed must also display a label referring to the enclosed module. This exterior label can use following wording: For M7DB6 modules, Contains Transmitter Module IC ID: 8407A-M7DB6 or Contains IC ID: 8407A-M7DB6. For M7DB modules, Contains Transmitter Module IC ID: 8407A-M7DB7 or Contains IC ID: 8407A-M7DB7. User manuals for license-exempt radio apparatus shall contain the above-mentioned statement or equivalent notice in a conspicuous location in the user manual or alternatively on the device or both.

Warning:

1. The device for operation in the band 5150–5250 MHz is only for indoor use to reduce the potential for harmful interference to co-channel mobile satellite systems.
2. For devices with detachable antenna(s), the maximum antenna gain permitted for devices in the bands 5250-5350 MHz and 5470-5725 MHz shall be such that the equipment still complies with the e.i.r.p. limit.

- For devices with detachable antenna(s), the maximum antenna gain permitted for devices in the band 5725-5850 MHz shall be such that the equipment still complies with the e.i.r.p. limits specified for point-to-point and non-point-to-point operation as appropriate; and

The high-power radars are allocated as primary users (i.e., priority users) of the bands 5250-5350 MHz and 5650-5850 MHz and that these radars could cause interference and/or damage to LE-LAN devices.

DFS (Dynamic Frequency Selection) products that operate in the bands 5250- 5350 MHz, 5470-5600MHz, and 5650-5725MHz.

This device is not capable of transmitting in the band 5600-5650 MHz in Canada.

Avertissement:

- Le dispositif fonctionnant dans la bande 5150-5250 MHz est réservé uniquement pour une utilisation à l'intérieur afin de réduire les risques de brouillage préjudiciable aux systèmes de satellites mobiles utilisant les mêmes canaux;
- Le gain maximal d'antenne permis pour les dispositifs avec antenne(s) amovible(s) utilisant les bandes 5250-5350 MHz et 5470-5725 MHz doit se conformer à la limitation P.I.R.E.
- Le gain maximal d'antenne permis pour les dispositifs avec antenne(s) amovible(s) utilisant la bande 5725-5850 MHz doit se conformer à la limitation P.I.R.E spécifiée pour l'exploitation point à point et non point à point, selon le cas.

En outre, les utilisateurs devraient aussi être avisés que les utilisateurs de radars de haute puissance sont désignés utilisateurs principaux (c.-à-d., qu'ils ont la priorité) pour les bandes 5250-5350 MHz et 5650-5850 MHz et que ces radars pourraient causer du brouillage et/ou des dommages aux dispositifs LAN-EL.

Les produits utilisant la technique d'atténuation DFS (sélection dynamique des réquences) sur les bandes 5250-5350 MHz, 5470-5600MHz et 5650-5725MHz.

Cet appareil ne peut pas émettre dans la bande 5600-5650 MHz au Canada.

8.2.3 CE

The modules are in conformity with the essential requirements and other relevant requirements of the R&TTE Directive (1999/5/EC) for M7DB6 and RE Directive 2014/53/EU for M7DB. The product is conformity with the following standards and/or normative documents.

- EMC EN 301 489 – 1 V2.2.3(2019-11) & EN 301 489 – 17 V3.2.4 (2020-09)
- Radiated emissions EN 300 328 V2.2.2 (2019-07)
- Safety standards: IEC62368 – 1:2014(Second Edition & EN62368 – 1:2014 / A11:2017

8.2.4 TELEC

Telefication, operating as Conformity Assessment Body (CAB ID Number:201 and 211) with respect to Japan, declares that the M7DB6 and M7DB complies with Technical Regulations Conformity Certification of specified Radio equipment (ordinance of MPT N° 37,1981)

- The validity of this Certificate is limited to products, which are equal to the one examined in the type-examination
- when the manufacturer (or holder of this certificate) is placing the product on the Japanese market, the product must be affixed with the following Specified Radio Equipment marking R201-190292 for M7DB6, and R211-210212 for M7DB.

8.2.5 Qualified Antenna Types

This device has been designed to operate with the antennas listed below. Antennas not included in this list or having a gain greater than listed gains in each region are strictly prohibited for use with this device. The required antenna impedance is 50 ohms.

Any antenna that is of the same type and of equal or less directional gain can be used without a need for retesting. To reduce potential radio interference to other users, the antenna type and its gain should be so chosen that the equivalent isotropically radiated power (e.i.r.p.) is not more than that permitted for successful communication. Using an antenna of a different type or gain more than certified gain will require additional testing.

8.2.5.1 M7DB6

Brand	Antenna Model	Antenna Type	Gain		Qualified Region
			2.4 GHz	5 GHz	
Silicon Labs	RSIA7	PCB Trace Antenna	0.712 dBi	1.25 dBi	FCC/IC, CE, TELEC
Taoglas	GW.71.5153	Dipole Antenna	3.8 dBi (Bent) 3.3 dBi (Straight)	5.5 dBi (Bent) 4.9 dBi (Straight)	FCC/IC, TELEC

Table 42. Qualified Antenna List for M7DB6

8.2.5.2 M7DB

Brand	Antenna Model	Antenna Type	Gain		Qualified Region
			2.4 GHz	5 GHz	
Silicon Labs	RSIA7	PCB Trace Antenna	0.712 dBi	1.25 dBi	FCC/IC, CE, TELEC
Taoglas	GW.71.5153	Dipole Antenna	3.8 dBi (Bent) 3.3 dBi (Straight)	5.5 dBi (Bent) 4.9 dBi (Straight)	FCC/IC, CE, TELEC
Smarteq	4211613980	PIFA	0 dBi	2.0 dBi	FCC/IC, CE, TELEC
Inside WLAN	PRO-IS-299	Dipole	2.5 dBi	1.6 dBi	FCC/IC, CE, TELEC
Joinsoon Electronics Mfg. Co., Ltd	MARS-31A8 WiFi Antenna	PIFA	2.0 dBi	2.0 dBi	FCC/IC, CE, TELEC

Table 43. Qualified Antenna List for M7DB

8.2.6 Module Marking Information

The figure and table below illustrate the marking on the Dual band module, and explains the marking on the module

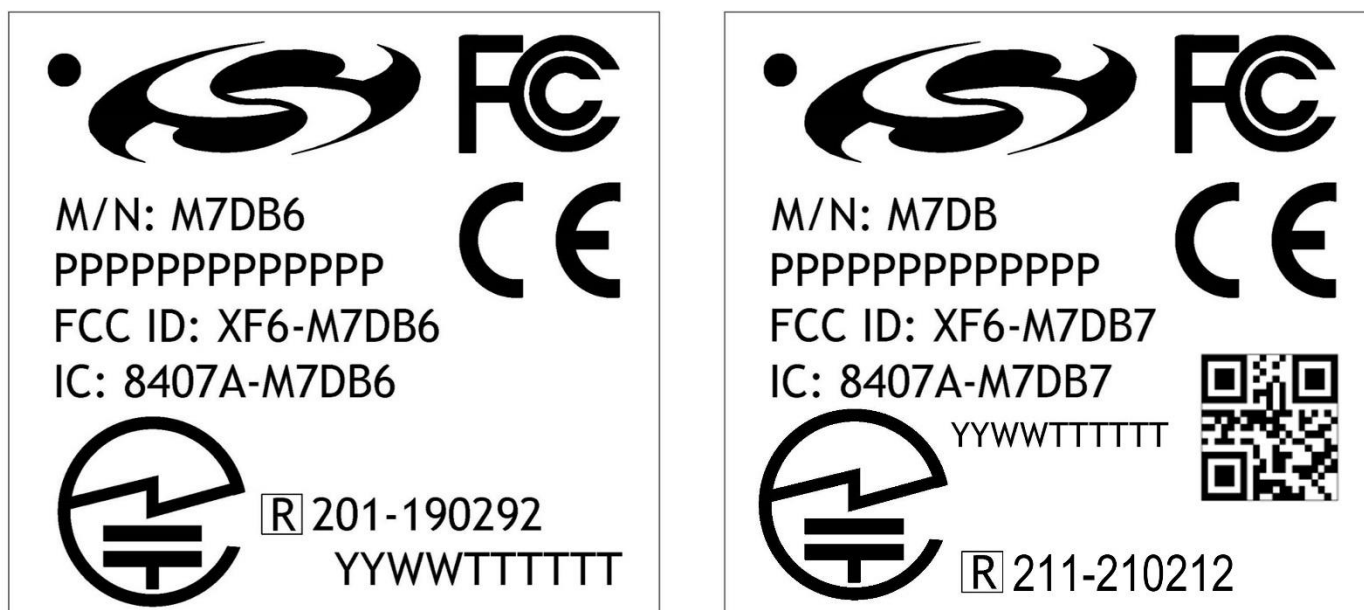





Figure 46. Module Marking Information

Marking		Description
Model	M7DB6 M7DB	Model Number for Dual-band modules
Part Number	PPPPPPPPPPPP	Part Number Designation
FCC	XF6-M7DB6 XF6-M7DB7	FCC Grant ID for Dual-band modules.
IC	8407A-M7DB6 8407A-M7DB7	IC Grant ID for Dual-band modules.
Lot Code Information	YYWWTTTTTT	YY – Year of assembly WW – 2-digit work week when device was assembled TTTTTT – Trace or manufacturing code. The first letter is the device revision (B = Silicon Rev 1.4)
Compliance Marks		FCC Compliance Mark
		CE Compliance Mark
		TELEC Compliance Mark
Barcode	YYWWMMABCDE 	YY – Last 2 digit of Year (e.g.: 21 for 2021) WW – Work Week (01 – 53) MMABCDE – Silicon Labs Unit Code

8.3 Module Package

Package Code	Package Type, Pins	Dimensions (mm)	Frequency Band	Integrated Antenna
CC1	SIP, LGA (155)	15.0 x 15.70 x 2.2	Dual Band (2.4 GHz / 5 GHz)	Antenna and u.FL Connector

Table 44. CC1 Module Package

8.4 Ordering Information

Part Number	Wireless
Hosted Connectivity (n-Link)	
RS9116N-DB00-CC1-B00	DBW+BT5; Rev 1.4 Silicon
Embedded Connectivity (WiSeConnect)	
RS9116W-DB00-CC1-B2A	DBW+BT5; Rev 1.4 Silicon; Firmware Version: 2.0 to 2.4
RS9116W-DB00-CC1-B2B	DBW+BT5; Rev 1.4 Silicon; Firmware Version: 2.5 or higher

Table 45. Part Ordering Options

Notes:

- The above WiSeConnect parts are considered MIC certified if they are updated to Firmware Version 2.5 or higher.
- The above n-Link part is considered MIC certified if it is loaded with driver version 2.5.1 or higher.
- DBW: Dual Band Wi-Fi (2.4/5 GHz)
- Customer should include provision for programming or updating the firmware at manufacturing.

9 RS9116 CC1 Module Documentation and Support

Silicon Labs offers a set of documents which provide further information required for evaluating and developing products and applications using RS9116. These documents are available in [RS9116 Document Library](#) on the Silicon Labs website. The documents include information related to Software releases, Evaluation Kits, User Guides, Programming Reference Manuals, Application Notes, and others.

For further assistance, you can contact Silicon Labs Technical Support [here](#).

9.1 Resource Location

RS9116 Document Library: <https://docs.silabs.com/rs9116/>

Technical Support: <http://www.silabs.com/support/>

10 RS9116 CC1 Module Revision History

Revision No.	Version No.	Date	Changes
1	1.0	April, 2019	Initial version
2	1.0.1	May, 2019	<ul style="list-style-type: none"> Updated host-based schematics. Combined SDIO, SPI & UART host interfaces into one schematic. Combined USB and USB-CDC host interfaces into one schematic Updated 32 Khz external oscillator specifications Updated the Schematics for UART_RTS and UART_CTS Pin correction.
3	1.0.2	May, 2019	<p>Removed AVDD_1P3 from the Reference schematics, Pinout Diagram, Moved the pin from Power section to NC list.</p> <p>Removed 32KHz XTAL Pins and used UULP GPIO for feeding in the External Clock. Updated the below sections for the same</p> <ul style="list-style-type: none"> Pinout Description. Specifications Reference Schematics
4	1.0.3	July, 2019	<ul style="list-style-type: none"> Corrected the description of 32KHz external clock in Specifications section Added external control for POC_IN in Specifications Renamed LP_WAKEUP to LP_WAKEUP_IN and changed its description in Pinout section Added host detection details and updated network processor memory details in Detailed description. Removed PLL_AVDD from Recommended Operating conditions section Corrected the initial state of SDIO_D3 to pullup and SDIO_D2 to HighZ.
5	1.0.4	November, 2019	Bluetooth ACI specs corrected (earlier version shows under Typ – should have been under “Min”)
6	1.0.5	July, 2020	<ul style="list-style-type: none"> Added Qualified Antenna list for TELEC certification Added WLAN 5 GHz Receiver Characteristics (for Dual Band WiFi modules) Updated Applications section. Updated 40 MHz Clock specifications. Updated LED0 software configuration note for ULP_GPIO_8 under Pin Description. Mentioned need for weak pull up resistor under Pin Description to use Wake-on-Wireless feature on ULP_GPIO_6. Updated “Digital Input Output Signals” to separate readings at 3.3V and 1.8V. Included TELEC certification details and updated Module Marking Information. Updated Wireless Co-Existence modes in Features list. The number of center roles supported by BLE changed from 8 to 6.

Revision No.	Version No.	Date	Changes
			<ul style="list-style-type: none"> Added a note under Pin Description regarding functionalities that are available on multiple Pins, and their proper usage. Eg. SLEEP_IND_FROM_DEV Updated Generic PCB Layout Guidelines. Updated Power Sequence Diagrams under DC Characteristics for POC_IN and POC_OUT. Features list updated. Added Antenna Specifications. Reflow profile diagram updated. Updated Typical values for BLE ACI characteristics. Updated GPIO pin descriptions.
7	1.0.6	August, 2020	<ul style="list-style-type: none"> Updated datasheet to reflect data specific to CC0. Updated Features List removed redundant information. Updated Applications, and Software Architecture Diagrams. Updated pin descriptions – ULP_GPIO_0 and ULP_GPIO_6. Updated Software section with latest information. Rebranded to Silicon Labs.
8	1.0.7	September, 2020	<ul style="list-style-type: none"> Updated Device Information with new nomenclature to include Silicon revision, and firmware version. Updated schematics to include the new nomenclature. SoC Ordering information updated with new OPNs; Device Nomenclature diagram updated.
9	1.0.8	December, 2020	<ul style="list-style-type: none"> Updated 2.4 GHz TX numbers using new gain tables. Band separation and updated values provided for TX and RX for 5 GHz RF characteristics. Updated Feature Set for Embedded Mode. Included DTIM 1 & 3 values at 5 GHz. Include qualified antenna types for M7DB7 module. Updated Module Marking Info to include M7DB7 and Silicon Labs logo. Updated Device Nomenclature.
10	1.0.9	June, 2021	<ul style="list-style-type: none"> Module image updated with Silicon Labs logo. Added note under Software Architecture diagram on connecting and using multiple hosts at the same time. Included EN 300 328 v2.2.2 certification info. Removed redundant section 'Device Information'. Same information is available in section 'Ordering Information'. Pin names updated for consistency; included actual pin names along with signals; updated pins: UART1_RX, UART1_TX, UART2_TX, HOST_BYP_ULP_WAKEUP ULP_GPIOs in Pin Description referenced to ULP_IO_VDD instead of IO_VDD_1.

Revision No.	Version No.	Date	Changes
			<ul style="list-style-type: none"> Updated note on Wake-on-Wireless feature, under Description for pin ULP_GPIO_6. Removed ESD and Latch Up information from Absolute Ratings table. Updated Min. and Max. values for RF related pins, and ULP_IO_VDD to reflect only 3.3 V in Recommended Operating Conditions. Updated SDIO_IO_VDD pin to include both 1.8 V and 3.3 V values in Recommended Operating Conditions. Removed mentions of pin PA2G_AVDD. This pin is not available in CC1 package. Power-Up and Down Sequence with POC_IN connected internally. Included statement that this connection is NRND. Updated V_{IH}, V_{OH} to show only Min. values; V_{IL}, V_{OL} to show only Max. values; I_{OL}, I_{OH} to show only Typ. values. Updated 32 kHz External Crystal Oscillator specifications to reflect correct Min and Max values for V_{ac}. Removed 40 MHz crystal specification because the crystal is integrated inside the module. Added a note under Clock Specifications. Timing data included for SDIO_CMD. Updated temperature and characterization variations for RF Tx and Rx readings. Added caveats to RF Characteristics. Updated RF Specification section to include numbers at 3.3 V only. Updated 2.4 GHz Transmitter characteristics at 11 Mbps and 6 Mbps to reflect corrected values based on latest ATE power index table. Updated Note for IEEE spectral mask effects. Added mention of AN1337 application note for certification details. Included output voltage power ranges under Power Management. Typical Current Consumption section updated to include values at 3.3 V only. Updated Power Consumption numbers for WLAN at 2.4 GHz and 5 GHz. Module M7DB7 rebranded to M7DB as per existing naming guidelines. Removed Device Nomenclature. Removed Reflow Profile, Soldering and Baking instructions. Information available through the web based RFI system. Datasheet updated from Preliminary to Full Production.
11	1.0.10	November, 2021	<ul style="list-style-type: none"> Updated Module marking information with Telec and 2D marking for M7DB. Added a small description for POC_IN and POC_OUT. Added conditions for the status of signals when they are driven by an external host.

Revision No.	Version No.	Date	Changes
			<ul style="list-style-type: none"> • Added description on status of USB_ID pin when not in use. • Added Power Up Sequence with EXT_PG_EN. • Provided Hardware Resetting sequence. • Updated Digital Input Output Signals and added a note for SDIO signal. • Added note under Reference Schematics regarding power supply to IO domain when any interface/signal is not used. • Updated UULP_VBATT power pins to reference to the correct minimum voltage under Power Management. • Output Voltage Specs updated for VOUTLDOAFE and VOUTSCDC. • Updated note under RF Characteristics to state that the 2 dBm variation is across parts and channels, and not channels alone. • Corrected Operating Voltage range and Temperature range under Features. • Removed redundant OPN RS9116W-DB00-CC0-B24.
12	1.0.11	August, 2022	<ul style="list-style-type: none"> • Updated to include OPN RS9116W-DB00-CC1-B2B with firmware v2.5. • Included SDIO interface support for WiSeConnect. • Updated Baseband processing data rate up to 72 Mbps for 802.11n single stream modes. • Updated module marking information with corrected description for Part number designation. • Minimum voltage rating for SDIO_IO_VDD pin updated to 1.75 V under Recommended Operating Conditions. • Added USB_VBUS pin information under Absolute Maximum Ratings and Recommended Operating Conditions. • Removed Reset pin voltages @1.8 V. • Updated Output Voltage Table ranges. • Updated Lot Code Information with B denoting silicon rev 1.4. • EVM related notes updated for MCS7. • Notes updated in RF characteristics section regarding Power variation across channels and part-to-part. • Module image updated with the latest lot code. • Added RAM size and certificates loading into Flash. • Added Power-Up Sequence with USB as host interface.

Table 46. Revision History

Simplicity Studio

One-click access to MCU and wireless tools, documentation, software, source code libraries & more. Available for Windows, Mac and Linux!



IoT Portfolio
www.silabs.com/loT



SW/HW
www.silabs.com/simplicity



Quality
www.silabs.com/quality



Support & Community
www.silabs.com/community

Disclaimer

Silicon Labs intends to provide customers with the latest, accurate, and in-depth documentation of all peripherals and modules available for system and software implementers using or intending to use the Silicon Labs products. Characterization data, available modules and peripherals, memory sizes and memory addresses refer to each specific device, and "Typical" parameters provided can and do vary in different applications. Application examples described herein are for illustrative purposes only. Silicon Labs reserves the right to make changes without further notice to the product information, specifications, and descriptions herein, and does not give warranties as to the accuracy or completeness of the included information. Without prior notification, Silicon Labs may update product firmware during the manufacturing process for security or reliability reasons. Such changes will not alter the specifications or the performance of the product. Silicon Labs shall have no liability for the consequences of use of the information supplied in this document. This document does not imply or expressly grant any license to design or fabricate any integrated circuits. The products are not designed or authorized to be used within any FDA Class III devices, applications for which FDA premarket approval is required or Life Support Systems without the specific written consent of Silicon Labs. A "Life Support System" is any product or system intended to support or sustain life and/or health, which, if it fails, can be reasonably expected to result in significant personal injury or death. Silicon Labs products are not designed or authorized for military applications. Silicon Labs products shall under no circumstances be used in weapons of mass destruction including (but not limited to) nuclear, biological or chemical weapons, or missiles capable of delivering such weapons. Silicon Labs disclaims all express and implied warranties and shall not be responsible or liable for any injuries or damages related to use of a Silicon Labs product in such unauthorized applications.

Note: This content may contain offensive terminology that is now obsolete. Silicon Labs is replacing these terms with inclusive language wherever possible. For more information, visit www.silabs.com/about-us/inclusive-lexicon-project

Trademark Information

Silicon Laboratories Inc.[®], Silicon Laboratories[®], Silicon Labs[®], SiLabs[®] and the Silicon Labs logo[®], Bluegiga[®], Bluegiga Logo[®], Clockbuilder[®], CMEMS[®], DSPLL[®], EFM[®], EFM32[®], EFR[®], Ember[®], Energy Micro, Energy Micro logo and combinations thereof, "the world's most energy friendly microcontrollers", Ember[®], EZLink[®], EZRadio[®], EZRadioPRO[®], Gecko[®], Gecko OS, Gecko OS Studio, ISOModem[®], Precision32[®], ProSLIC[®], Simplicity Studio[®], SiPHY[®], Telegesis, the Telegesis Logo[®], USBXpress[®], Zentri, the Zentri logo and Zentri DMS, Z-Wave[®], and others are trademarks or registered trademarks of Silicon Labs. ARM, CORTEX, Cortex-M3 and THUMB are trademarks or registered trademarks of ARM Holdings. Keil is a registered trademark of ARM Limited. Wi-Fi is a registered trademark of the Wi-Fi Alliance. All other products or brand names mentioned herein are trademarks of their respective holders.



Silicon Laboratories Inc.
400 West Cesar Chavez
Austin, TX 78701
USA

www.silabs.com