

## HEIDI-D

~10° diffused spot beam

### TECHNICAL SPECIFICATIONS:

Dimensions	Ø 21.6 mm
Height	11.9 mm
Fastening	tape, pin
ROHS compliant	yes ⓘ



### MATERIAL SPECIFICATIONS:

Component	Type	Material	Colour	Finish
HEIDI-D	Single lens	PMMA	clear	
HEIDI-TAPE	Tape	Acrylic foam	black	

### ORDERING INFORMATION:

Component		Qty in box	MOQ	MPQ	Box weight (kg)
CA11264_HEIDI-D	Single lens	3264	204	204	10.6
» Box size: 480 x 280 x 300 mm					

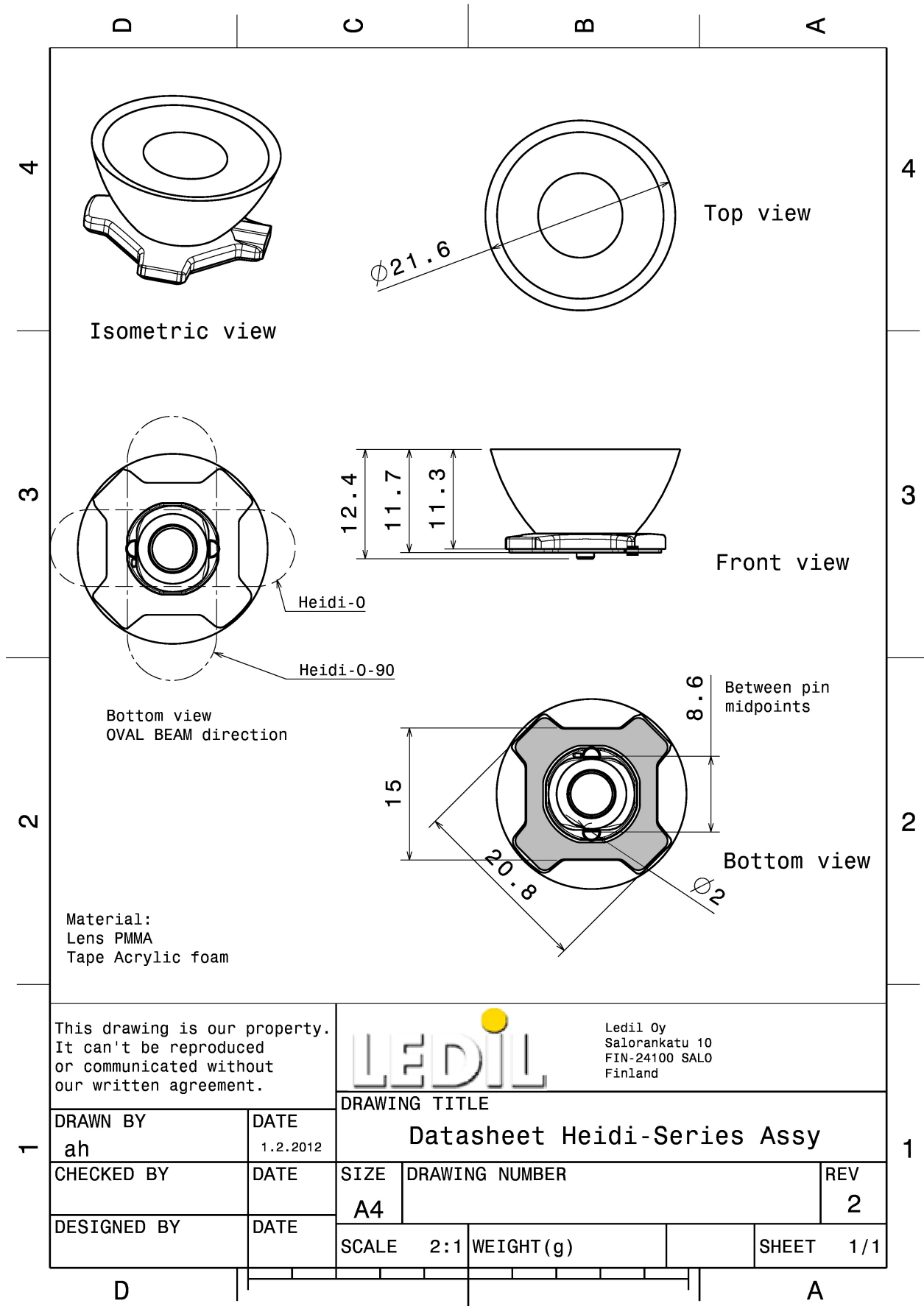

See also our general installation guide: [www.ledil.com/installation\\_guide](http://www.ledil.com/installation_guide)

### PHOTOMETRIC DATA (MEASURED):

#### CREE → LED

LED XB-D  
FWHM / FWTM 10.0° / 22.0°  
Efficiency 90 %  
Peak intensity 12.6 cd/lm  
LEDs/each optic 1  
Light colour White  
Required components:

#### CREE → LED

LED XB-H  
FWHM / FWTM 11.0° / 25.0°  
Efficiency 87 %  
Peak intensity 12.7 cd/lm  
LEDs/each optic 1  
Light colour White  
Required components:



#### CREE → LED

LED XD16  
FWHM / FWTM 10.0° / 22.0°  
Efficiency 93 %  
Peak intensity 14.1 cd/lm  
LEDs/each optic 1  
Light colour White  
Required components:

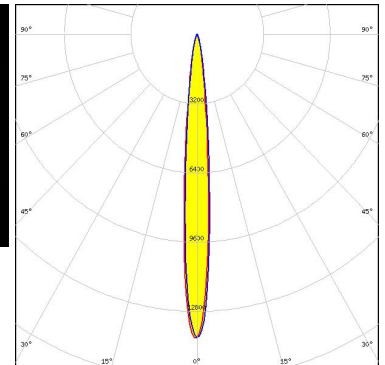

#### CREE → LED

LED XP-E  
FWHM / FWTM 9.0° / 18.0°  
Efficiency 93 %  
Peak intensity 22 cd/lm  
LEDs/each optic 1  
Light colour White  
Required components:

### PHOTOMETRIC DATA (MEASURED):

#### CREE → LED

LED XP-E2  
 FWHM / FWTM 10.0° / 23.0°  
 Efficiency 88 %  
 Peak intensity 17.4 cd/lm  
 LEDs/each optic 1  
 Light colour White  
 Required components:

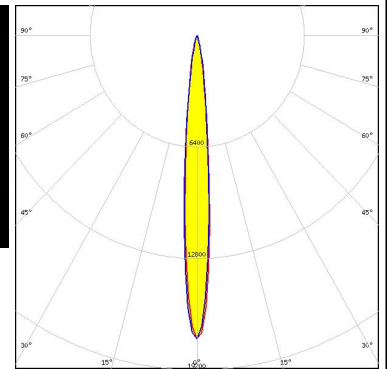

#### CREE → LED

LED XP-G  
 FWHM / FWTM 12.0° / 23.0°  
 Efficiency 93 %  
 Peak intensity 14.5 cd/lm  
 LEDs/each optic 1  
 Light colour White  
 Required components:

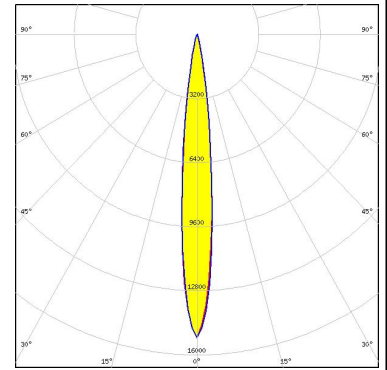

#### CREE → LED

LED XP-G2  
 FWHM / FWTM 11.0° / 24.0°  
 Efficiency 88 %  
 Peak intensity 15 cd/lm  
 LEDs/each optic 1  
 Light colour White  
 Required components:

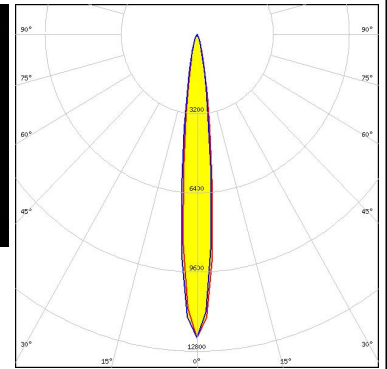

#### CREE → LED

LED XQ-E HD  
 FWHM / FWTM 10.0° / 24.0°  
 Efficiency 94 %  
 Peak intensity 14.8 cd/lm  
 LEDs/each optic 1  
 Light colour White  
 Required components:

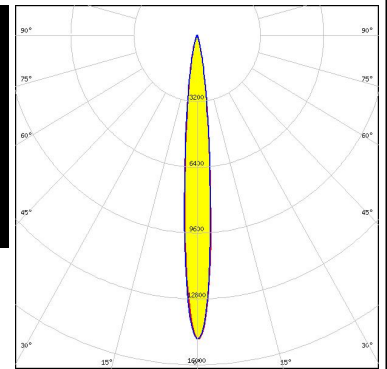
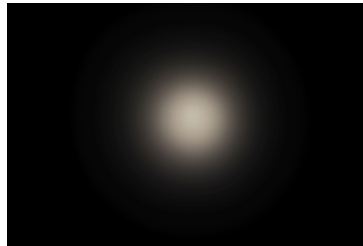

### PHOTOMETRIC DATA (MEASURED):

#### CREE LED

LED XQ-E HI  
 FWHM / FWTM 7.0° / 17.0°  
 Efficiency 93 %  
 Peak intensity 24.8 cd/lm  
 LEDs/each optic 1  
 Light colour White  
 Required components:

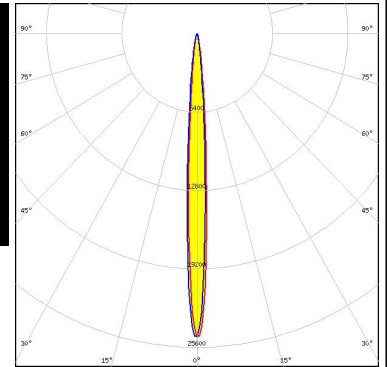

#### CREE LED

LED XT-E  
 FWHM / FWTM 11.0° / 26.0°  
 Efficiency 94 %  
 Peak intensity 11.6 cd/lm  
 LEDs/each optic 1  
 Light colour White  
 Required components:

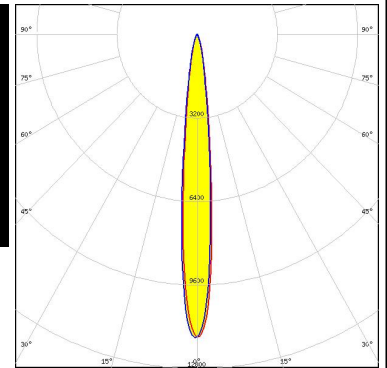

#### LUMILEDS

LED LUXEON C  
 FWHM / FWTM 9.0° / 21.0°  
 Efficiency 89 %  
 Peak intensity 17.8 cd/lm  
 LEDs/each optic 1  
 Light colour White  
 Required components:

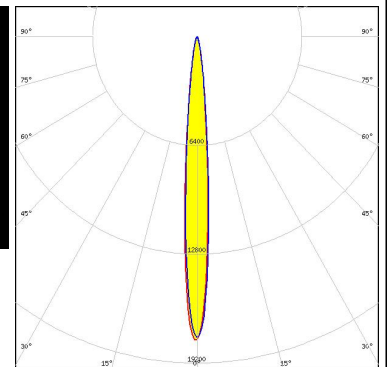

#### LUMILEDS

LED LUXEON CZ  
 FWHM / FWTM 7.0° / 16.0°  
 Efficiency 94 %  
 Peak intensity 29 cd/lm  
 LEDs/each optic 1  
 Light colour White  
 Required components:

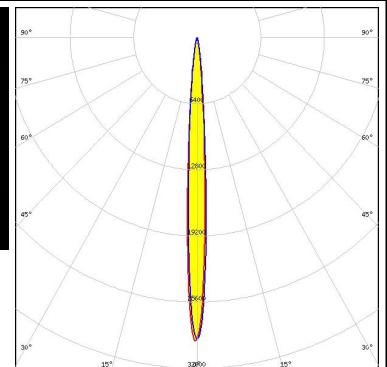

### PHOTOMETRIC DATA (MEASURED):

#### LUMILEDS

LED LUXEON T  
FWHM / FWTM 12.0° / 25.0°  
Efficiency 89 %  
Peak intensity 11.5 cd/lm  
LEDs/each optic 1  
Light colour White  
Required components:

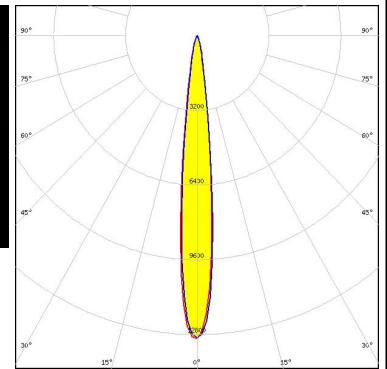

#### LUMILEDS

LED LUXEON TX  
FWHM / FWTM 12.0° / 25.0°  
Efficiency 88 %  
Peak intensity 13.6 cd/lm  
LEDs/each optic 1  
Light colour White  
Required components:

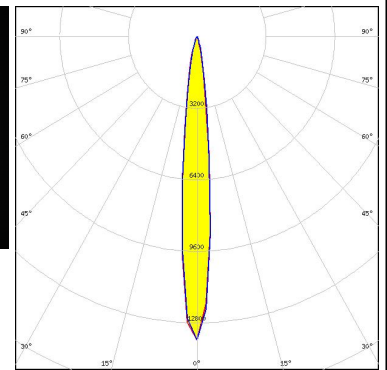
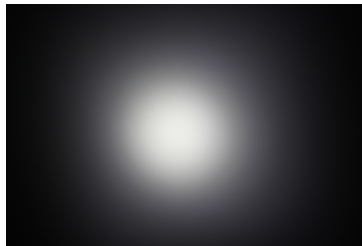

#### NICHIA

LED NCSxx19A  
FWHM / FWTM 9.0° / 23.0°  
Efficiency 88 %  
Peak intensity 11.9 cd/lm  
LEDs/each optic 1  
Light colour White  
Required components:



#### NICHIA

LED NCSxx19B  
FWHM / FWTM 11.0° / 25.0°  
Efficiency 85 %  
Peak intensity 14.2 cd/lm  
LEDs/each optic 1  
Light colour White  
Required components:

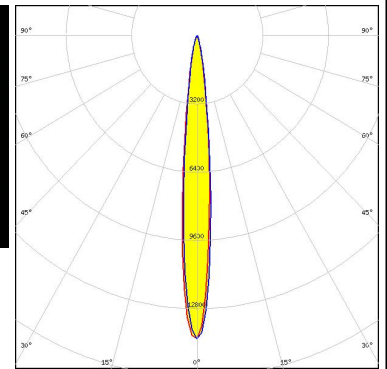

### PHOTOMETRIC DATA (MEASURED):



LED NVSxx19A  
FWHM / FWTM 12.0° / 29.0°  
Efficiency 88 %  
Peak intensity 8.9 cd/lm  
LEDs/each optic 1  
Light colour White  
Required components:



LED NVSxx19B/NVSxx19C  
FWHM / FWTM 14.0° / 30.0°  
Efficiency 91 %  
Peak intensity 10 cd/lm  
LEDs/each optic 1  
Light colour White  
Required components:

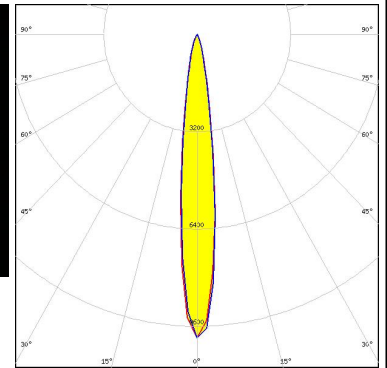
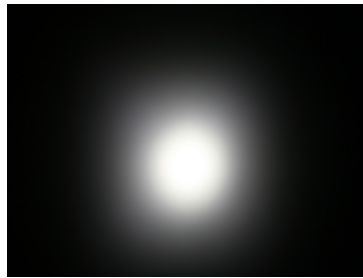

Osram Opto Semiconductors

LED OSLOM Square EC  
FWHM / FWTM 10.0° / 22.0°  
Efficiency 90 %  
Peak intensity 12.9 cd/lm  
LEDs/each optic 1  
Light colour White  
Required components:



Osram Opto Semiconductors

LED OSLOM SSL 150  
FWHM / FWTM 9.0° / 22.0°  
Efficiency 92 %  
Peak intensity 15 cd/lm  
LEDs/each optic 1  
Light colour White  
Required components:

#### PHOTOMETRIC DATA (MEASURED):

#### OSRAM

Opto Semiconductors

LED OSLOM SSL 80  
 FWHM / FWTM 7.0° / 19.0°  
 Efficiency 89 %  
 Peak intensity 19.3 cd/lm  
 LEDs/each optic 1  
 Light colour White  
 Required components:

#### SAMSUNG

LED LH181A  
 FWHM / FWTM 10.0° / 26.0°  
 Efficiency 88 %  
 Peak intensity 10 cd/lm  
 LEDs/each optic 1  
 Light colour White  
 Required components:

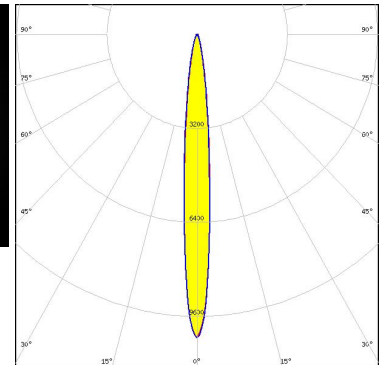

#### SAMSUNG

LED LH181B  
 FWHM / FWTM 11.0° / 25.0°  
 Efficiency 94 %  
 Peak intensity 11.8 cd/lm  
 LEDs/each optic 1  
 Light colour White  
 Required components:

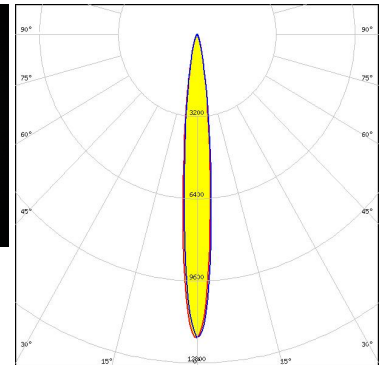

#### SAMSUNG

LED LH351B  
 FWHM / FWTM 14.0° / 29.0°  
 Efficiency 88 %  
 Peak intensity 10 cd/lm  
 LEDs/each optic 1  
 Light colour White  
 Required components:

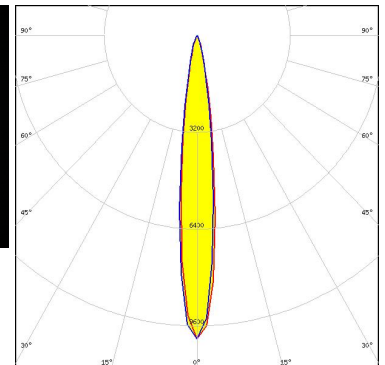
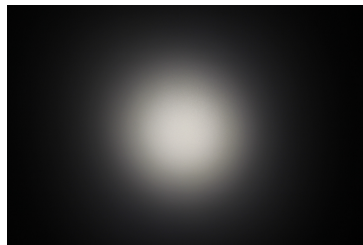



### PHOTOMETRIC DATA (MEASURED):

#### SAMSUNG

LED LH351Z  
FWHM / FWTM 12.0° / 26.0°  
Efficiency 88 %  
Peak intensity 13.3 cd/lm  
LEDs/each optic 1  
Light colour White  
Required components:

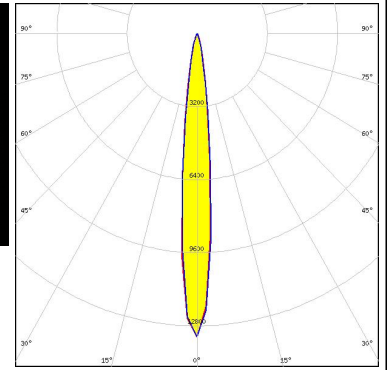

SEOUL SEMICONDUCTOR

LED Z5  
FWHM / FWTM 8.0° / 20.0°  
Efficiency 87 %  
Peak intensity 22.3 cd/lm  
LEDs/each optic 1  
Light colour White  
Required components:

### PHOTOMETRIC DATA (SIMULATED):



LED XP-E2  
 FWHM / FWTM 10.0° / 20.0°  
 Efficiency 96 %  
 Peak intensity 22.6 cd/lm  
 LEDs/each optic 1  
 Light colour Green  
 Required components:

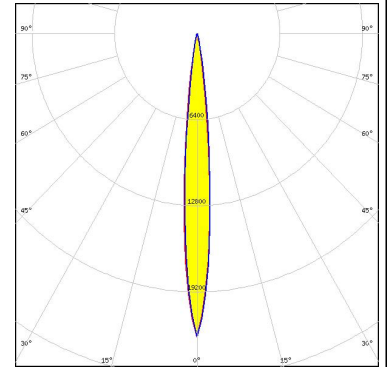

LED XP-L HI  
 FWHM / FWTM 12.0° / 22.0°  
 Efficiency 96 %  
 Peak intensity 15.9 cd/lm  
 LEDs/each optic 1  
 Light colour White  
 Required components:

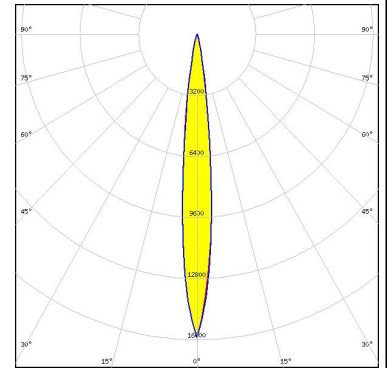

LED LUXEON 3030 HV  
 FWHM / FWTM 11.0° / 23.0°  
 Efficiency 94 %  
 Peak intensity 16.4 cd/lm  
 LEDs/each optic 1  
 Light colour White  
 Required components:

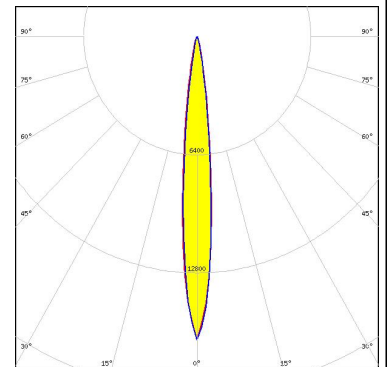

LED LUXEON SunPlus 20 Line (120 deg)  
 FWHM / FWTM 8.0° / 18.0°  
 Efficiency 96 %  
 Peak intensity 26.7 cd/lm  
 LEDs/each optic 1  
 Light colour White  
 Required components:

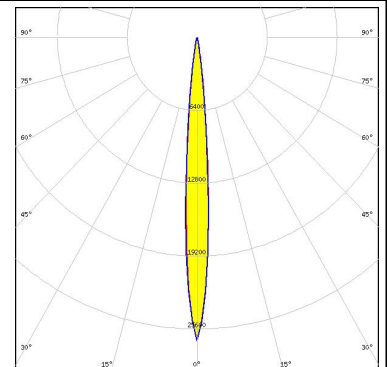

### PHOTOMETRIC DATA (SIMULATED):

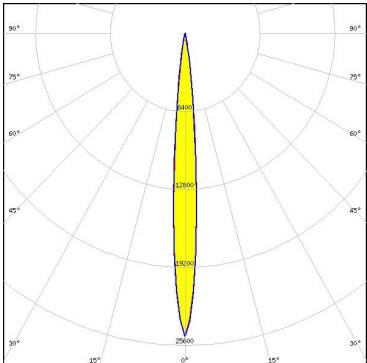
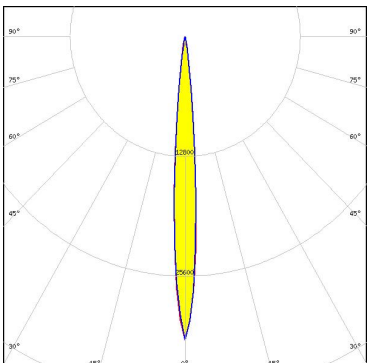
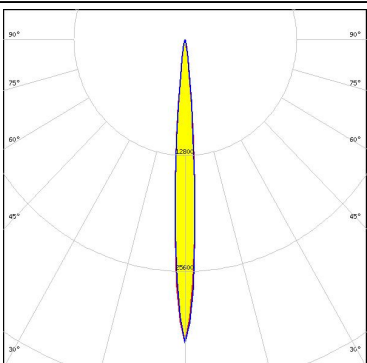
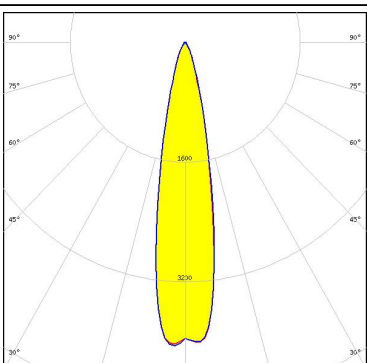
<p><b>LUMILEDS</b></p> <p>LED LUXEON SunPlus 20 Line (150 deg)</p> <p>FWHM / FWTM 8.0° / 18.0°</p> <p>Efficiency 91 %</p> <p>Peak intensity 24.9 cd/lm</p> <p>LEDs/each optic 1</p> <p>Light colour White</p> <p>Required components:</p>	
<p><b>LUMILEDS</b></p> <p>LED LUXEON Z</p> <p>FWHM / FWTM 9.0° / 17.0°</p> <p>Efficiency 94 %</p> <p>Peak intensity 32.4 cd/lm</p> <p>LEDs/each optic 1</p> <p>Light colour White</p> <p>Required components:</p>	
<p><b>LUMILEDS</b></p> <p>LED LUXEON Z ES</p> <p>FWHM / FWTM 7.7° / 16.0°</p> <p>Efficiency 94 %</p> <p>Peak intensity 33.5 cd/lm</p> <p>LEDs/each optic 1</p> <p>Light colour White</p> <p>Required components:</p>	
<p><b>NICHIA</b></p> <p>LED NCSxE17A</p> <p>FWHM / FWTM 22.0° / 42.0°</p> <p>Efficiency 93 %</p> <p>Peak intensity 4.1 cd/lm</p> <p>LEDs/each optic 4</p> <p>Light colour White</p> <p>Required components:</p>	

#### PHOTOMETRIC DATA (SIMULATED):

<b>OSRAM</b> <small>Opto Semiconductors</small>	<p>LED Duris S5 (Single chip)</p> <p>FWHM / FWTM 12.0° / 24.0°</p> <p>Efficiency 96 %</p> <p>Peak intensity 14.2 cd/lm</p> <p>LEDs/each optic 1</p> <p>Light colour White</p> <p>Required components:</p>	
<b>OSRAM</b> <small>Opto Semiconductors</small>	<p>LED OSCONIQ P 3030</p> <p>FWHM / FWTM 9.4° / 20.0°</p> <p>Efficiency 97 %</p> <p>Peak intensity 23.1 cd/lm</p> <p>LEDs/each optic 1</p> <p>Light colour White</p> <p>Required components:</p>	
<b>OSRAM</b> <small>Opto Semiconductors</small>	<p>LED OSLON Square CSSRM2/CSSRM3</p> <p>FWHM / FWTM 13.0° / 26.0°</p> <p>Efficiency 94 %</p> <p>Peak intensity 13.3 cd/lm</p> <p>LEDs/each optic 1</p> <p>Light colour White</p> <p>Required components:</p>	
<b>OSRAM</b> <small>Opto Semiconductors</small>	<p>LED SFH 4170S</p> <p>FWHM / FWTM 9.0° / 17.0°</p> <p>Efficiency 88 %</p> <p>LEDs/each optic 1</p> <p>Light colour IR</p> <p>Required components:</p>	

### PHOTOMETRIC DATA (SIMULATED):



### GENERAL INFORMATION:

NOTE: The typical beam angle will be changed by different color, chip size and chip position tolerance. The typical total beam angle is the full angle measured where the luminous intensity is half of the peak value.

### MATERIALS:

As part of our continuous research and improvement processes, and to ensure the best possible quality and availability of our products, LEDiL reserves the right to change material grades without notice.

### PRODUCT DATA USER AGREEMENT AND DISCLAIMER:

The measured data in the provided downloadable LEDiL Product Datasheets and Mechanical 2D-Drawings is rounded and provided as reference for planning. LEDiL Oy's optical specifications have been verified by conducting performance testing of the products in accordance with the company's quality system. The reported data are averaged results of multiple measurements with typical variation. LEDiL Oy reserves the right to without prior notification make changes and improvements to its products.

LEDiL Oy assumes neither warranty, nor guarantee nor any other liability of any kind for the contents and correctness of the provided data. The provided data has been generated with highest diligence but the provided data may in reality not represent the complete possible variation range of all intrinsic parameters. Therefore, in certain cases a deviation from the provided data could occur.

LEDiL Oy reserves the right to undertake technical changes of its products without further notification which could lead to changes in the provided data. LEDiL Oy assumes no liability of any kind for the possible deviation from any provided data or any other damage resulting from the usage of the provided data.

The user agrees to this disclaimer and user agreement with the download or usage of the provided files.

#### LEDiL Oy

Joensuunkatu 13  
FI-24240 SALO  
Finland

#### LEDiL Inc.

228 West Page Street  
Suite D  
Sycamore IL 60178  
USA

#### Ledil Optics Technology (Shenzhen) Co., Ltd.

# 405 , Block B  
Casic Motor Building  
Shenzhen 518057  
P.R.CHINA

#### Local sales and technical support

[www.ledil.com/  
where\\_to\\_buy](http://www.ledil.com/where_to_buy)

#### Shipping locations

Salo, Finland  
Hong Kong, China

#### Distribution Partners

[www.ledil.com/  
where\\_to\\_buy](http://www.ledil.com/where_to_buy)