

HF14FW

MINIATURE HIGH POWER RELAY



File No.:E134517



File No.:40023508



File No.:CQC10002046170



Features

- 20A switching capability
- 4kV dielectric strength (between coil and contacts)
- Meeting VDE 0700, 0631 reinforce insulation
- 1 Form A and 1 Form C configurations
- Sockets available
- Plastic sealed and flux proofed types available

CONTACT DATA

Contact arrangement	1A, 1B, 1C
Contact resistance ²⁾	50mΩ max.(at 1A 24VDC)
Contact material	AgSnO ₂
Contact rating	Resistive: 16A 277VAC/24VDC 1HP 240VAC TV-8 125VAC (NO contact)
Max. switching voltage	277VAC / 30VDC
Max. switching current	20A
Max. switching power	5540VA / 480W
Mechanical endurance	1 x 10 ⁷ OPS
Electrical endurance	1 x 10 ⁵ OPS (NO or NC, 16A 277VAC, Resistive load, Room temp., 1s on 9s off) 5 x 10 ⁴ OPS (NO or NC, 16A 24VDC, Resistive load, Room temp., 1s on 9s off)

Notes: 1) The data shown above are initial values.

2) For plastic sealed type, the venting-hole should be excised in electrical endurance test.

CHARACTERISTICS

Insulation resistance	1000MΩ (at 500VDC)	
Dielectric strength	Between coil & contacts	4000VAC 1min
	Between open contacts	1000VAC 1min
Operate time (at rated. volt.)	15ms max.	
Release time (at rated. volt.)	5ms max.	
Ambient temperature	-40°C to 85°C	
Humidity	5% to 85% RH	
Shock resistance	Functional	98m/s ²
	Destructive	980m/s ²
Vibration resistance	10Hz to 55Hz 1.5mm DA	
Termination	PCB	
Unit weight	Approx. 18.5g	
Construction	Plastic sealed, Flux proofed	

Notes: 1) The data shown above are initial values.

2) Please find coil temperature curve in the characteristic curves below.

3) UL insulation system: Class F, Class B.

COIL

Coil power	Standard: Approx.720mW Sensitive: Approx.530mW
------------	---

COIL DATA

at 23°C

Standard type

Nominal Voltage VDC	Pick-up Voltage VDC max. ³⁾	Drop-out Voltage VDC min. ³⁾	Max. Voltage VDC ⁴⁾	Coil Resistance Ω
5	3.6	0.5	5.5	36 x (1±10%)
6	4.3	0.6	6.6	50 x (1±10%)
9	6.5	0.9	9.9	115 x (1±10%)
12	8.6	1.2	13.2	200 x (1±10%)
18	13.0	1.8	19.8	460 x (1±10%)
24	17.3	2.4	26.4	820 x (1±10%)
48	34.6	4.8	52.8	3300 x (1±10%)
60	43.2	6.0	66.0	5100 x (1±10%)

Sensitive type

Nominal Voltage VDC	Pick-up Voltage VDC max. ³⁾	Drop-out Voltage VDC min. ³⁾	Max. Voltage VDC ⁴⁾	Coil Resistance Ω
5	3.60	0.5	7.0	47 x (1±10%)
6	4.30	0.6	8.4	68 x (1±10%)
9	6.50	0.9	12.6	160 x (1±10%)
12	8.60	1.2	16.8	275 x (1±10%)
18	13.0	1.8	25.2	620 x (1±10%)
24	17.3	2.4	33.6	1100 x (1±10%)
48	34.6	4.8	67.2	4170 x (1±10%)
60	43.2	6.0	84.0	7000 x (1±10%)

Notes: 1) When requiring pick-up voltage < 72% of nominal voltage, special order allowed.

2) Suggesting to use the sensitive type.

3) The data shown above are initial values.

4) *Maximum voltage refers to the maximum voltage which relay coil could endure in a short period of time.

5) Under ambient temperature, applying more than 80% of rating voltage to coil, relay will take action accordingly. But in order to meet the stated product performance, please apply rated voltage to coil.



HONGFA RELAY

ISO9001, ISO/TS16949, ISO14001, OHSAS18001, IECQ QC 080000 CERTIFIED

2022 Rev. 1.00

SAFETY APPROVAL RATINGS

UL/CUL	Standard, Sensitive	AgSnO ₂	20A/16A/12A 277VAC Resistive 1HP (8 FLA) 240VAC TV-8 125VAC 16A 240VAC General Use 20A/16A/12A 24VDC 10FLA 60LRA 250VAC
	(136)	AgSnO ₂	20A 125VAC Resistive 20A 277VAC/250VAC/125VAC General Use 16A 277VAC/250VAC/125VAC Resistive 20A 30VDC Resistive 1/2HP 250VAC/125VAC TV-10 125VAC 10FLA 60LRA 250VAC
VDE (Coil power is 530mW)	AgSnO ₂	1 Form A	20A 250VAC at 70°C 16A 30VDC at 70°C
		1 Form C	16A 250VAC at 70°C 16A 30VDC at 70°C NO:20A 250VAC at 70°C

Notes: 1) All values unspecified are at room temperature.
2) Only typical loads are listed above. Other load specifications can be available upon request.

ORDERING INFORMATION

HF14FW / 012 -H S P T F (XXX)	
Type	
Coil voltage	5, 6, 9, 12, 18, 24, 48, 60VDC
Contact arrangement	H: 1Form A Z: 1 Form C
Construction ¹⁾	S: Plastic sealed(No smoky-gray or transparent cover) Nil: Flux proofed
Coil power	P: Standard Nil: Sensitive
Contact material	T: AgSnO ₂
Insulation standard	F: Class F Nil: Class B
Special code ⁴⁾	XXX: Customer special requirement Nil: Standard

Notes: 1) We recommend flux proofed types for a clean environment (free from contaminations like H₂S, SO₂, NO₂, dust, etc.). We suggest to choose plastic sealed types and validate it in real application for an unclean environment (with contaminations like H₂S, SO₂, NO₂, dust, etc).
2) Contact is recommended for suitable condition and specifications if water cleaning or surface process is involved in assembling relays on PCB.
3) The standard type is made of black cover. If smoky-gray or transparent cover is required, please add a special suffix (611) when ordering. Please take note that smoky-gray or transparent cover is only available for flux proofed.
4) The customer special requirement express as special code after evaluating by Hongfa.

OUTLINE DIMENSIONS, WIRING DIAGRAM AND PC BOARD LAYOUT

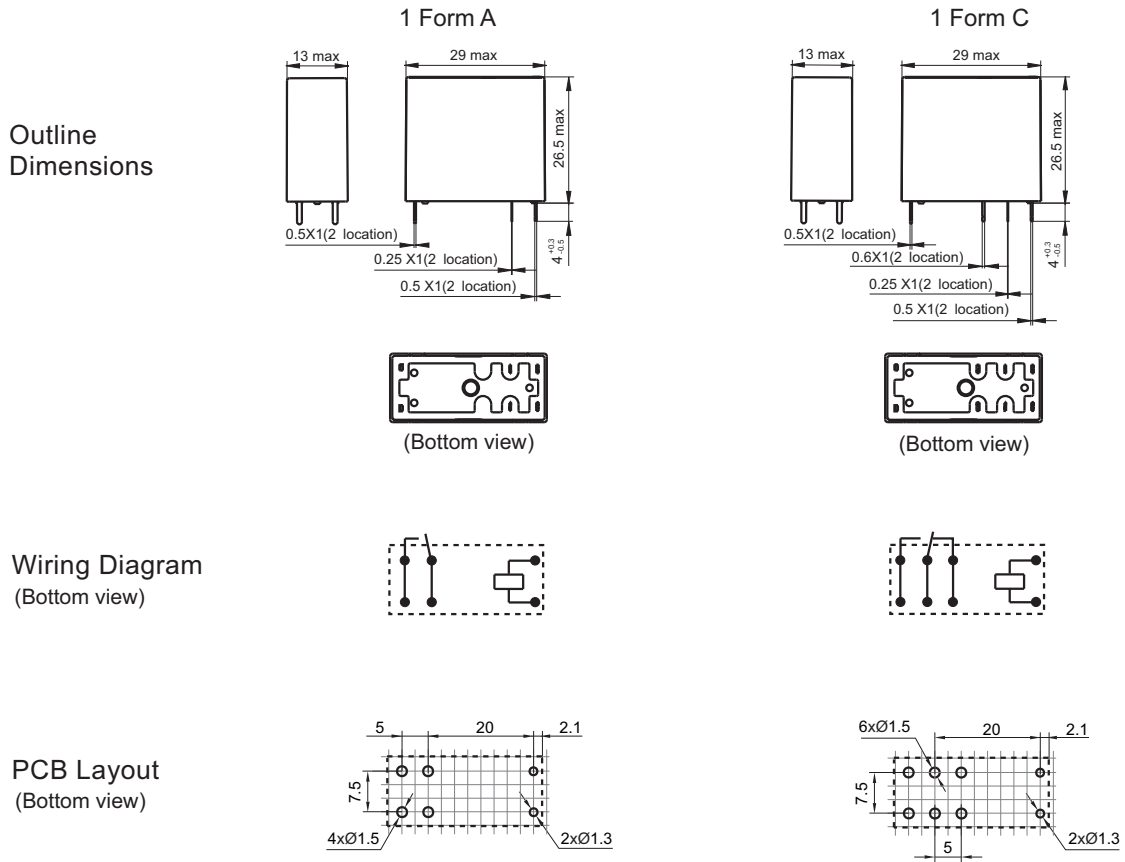

- Remark: 1) In case of no tolerance shown in outline dimension: outline dimension $\leq 1\text{mm}$, tolerance should be $\pm 0.2\text{mm}$; outline dimension $> 1\text{mm}$ and $\leq 5\text{mm}$, tolerance should be $\pm 0.3\text{mm}$; outline dimension $> 5\text{mm}$, tolerance should be $\pm 0.4\text{mm}$.
 2) The tolerance without indicating for PCB layout is always $\pm 0.1\text{mm}$.
 3) The width of the gridding is 2.5mm.

CHARACTERISTIC CURVES

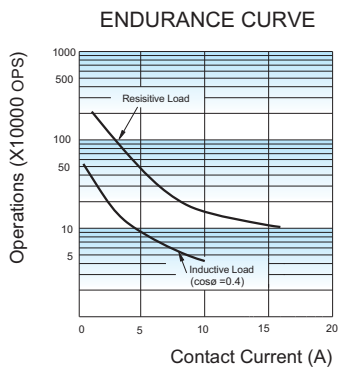

Test conditions:

No contact, Resistive load,
 Flux proofed, Room temp., 1s on 9s off.

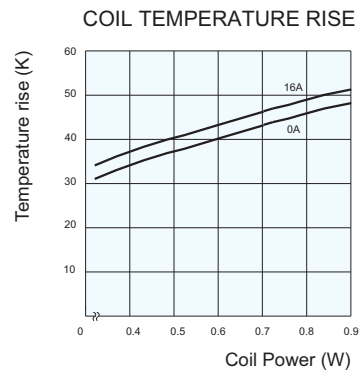

Relay Sockets

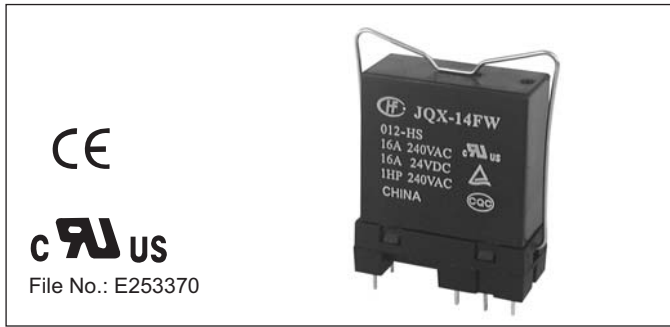

Features





- The insulation resistance is 1000MΩ
- Three mounting types are available: PCB, screw mounting and DIN rail mounting
- With finger protection device
- Many kinds of plug-in modules are available with the function of energizing indication and wiring protection
- Environmental friendly product (RoHS compliant)

CHARACTERISTICS

Type	Nominal Voltage	Nominal Current	Ambient Temperature	Dielectric Strengths.	Screw Torque	Wire Strip Length	Unit weight
14FF-2Z-A1	250VAC	10A	-40 °C to 70 °C	5000VAC	—	—	Approx.3g
14FF-2Z-C2	250VAC	10A	-40 °C to 70 °C	5000VAC	0.6N · m	7mm	Approx.39g
14FF-2Z-C3	250VAC	10A	-40 °C to 70 °C	5000VAC	0.6N · m	7mm	Approx.45g
14FF-2Z-C4	250VAC	10A	-40 °C to 70 °C	5000VAC	—	9mm	Approx.42g

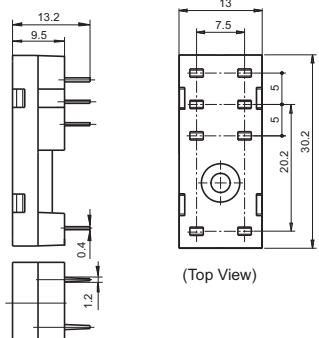
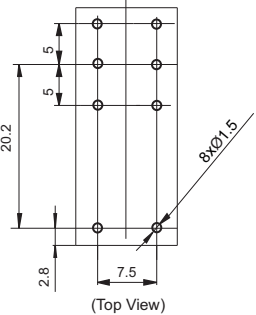
OUTLINE DIMENSIONS, WIRING DIAGRAM AND PC BOARD LAYOUT

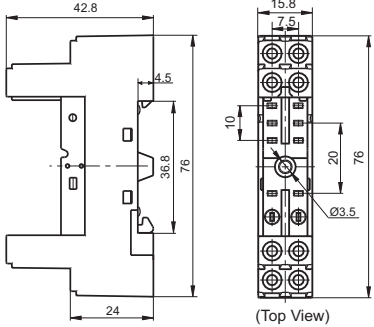
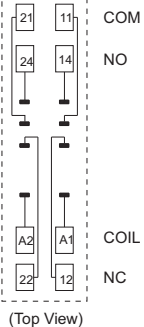
Unit: mm

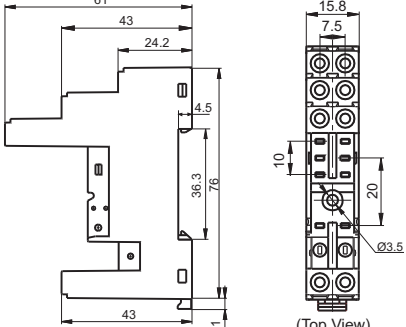
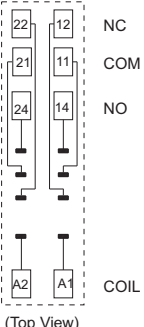
Socket	Outline Dimensions	Wiring Diagram / PCB Layout	Components Available
<p>14FF-2Z-A1</p>  <p>PCB terminal, PCB or Screw mounting</p>	 <p>(Top View)</p>	 <p>(Top View)</p>	<p>metallic retainer 14FF-H3</p> <p>remarks:the dielectric strength can reach 1500VAC that sockets mounted 14FF-H3</p>
<p>14FF-2Z-C2</p>  <p>Screw terminal DIN rail or Screw mounting With finger protection device</p>	 <p>(Top View)</p>	 <p>(Top View)</p>	<p>plastic retainer 14FF-H6</p> <p>marker 14FF-M1</p> <p>plug-in module HFAA to HFHU*</p>
<p>14FF-2Z-C3</p>  <p>Screw terminal DIN rail or Screw mounting With finger protection device</p>	 <p>(Top View)</p>	 <p>(Top View)</p>	<p>plastic retainer 14FF-H6</p> <p>marker 14FF-M1</p> <p>plug-in module HFAA to HFHU*</p>

OUTLINE DIMENSIONS, WIRING DIAGRAM AND PC BOARD LAYOUT

Unit: mm

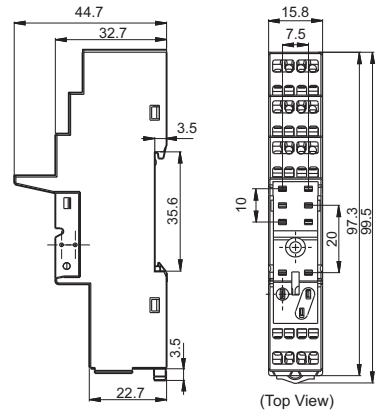
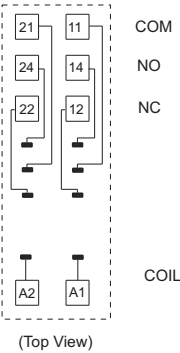
Socket	Outline Dimensions	Wiring Diagram / PCB Layout	Components Available
14FF-2Z-C4  Spring-loaded terminal DIN rail mounting With finger protection device			plastic retainer 14FF-H6 marker 14FF-M1 plug-in module HFAA to HFHU*

Notes: * Please refer to the product datasheet if plug-in module is required.

DIMENSION OF RELATED COMPONENT (AVAILABLE)

Unit: mm

Retainer

14FF-H3 (Metallic retainer)

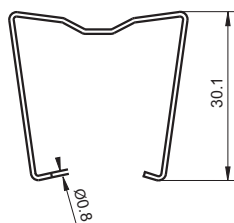

14FF-H6 (Plastic retainer)

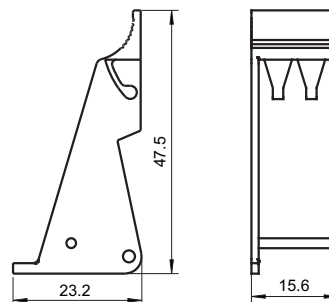

Marker

14FF-M1

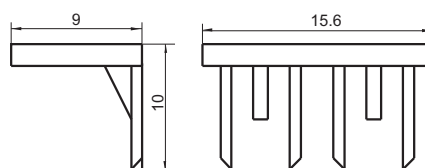

Things to be noticed when selecting sockets:

1. Please choose suitable relay socket according to the actual mounting environment, relay contact poles and terminal layout. If there is any query on selection, please contact Hongfa for the technical service.
2. Socket which can be mounted with markers is furnished with a marker; as for other related components, they should be selected separately. Please do give clear indication of the types of relay sockets and related components you choose while placing order.
3. The above is only an example of typical socket and related component type which is suitable to HF14FW relay. If you have any special requirements, please contact us.
4. Main outline dimension(L, W, H) ≥ 50 mm, tolerance should be ± 1 mm; outline dimension > 20 mm and < 50 mm, tolerance should be ± 0.5 mm; outline dimension ≤ 20 mm, tolerance should be ± 0.3 mm.
5. DIN rail mounting: recommend to use standard rail $35 \times 7.5 \times 1$ mm, $35 \times 15 \times 1$ mm.

Disclaimer

The specification is for reference only. See to "Terminology and Guidelines" for more information. Specifications subject to change without notice. We could not evaluate all the performance and all the parameters for every possible application. Thus the user should be in a right position to choose the suitable product for their own application. If there is any query, please contact Hongfa for the technical service. However, it is the user's responsibility to determine which product should be used only.

© Xiamen Hongfa Electroacoustic Co., Ltd. All rights of Hongfa are reserved.