



Disea Electronics Co., LTD

Tel:+86-0755-2373-1499 Fax:+86-0755-2373-1466

E-mail:sales@diseelec.com URL:www.diseelec.com

ADD: 4F,#3 Building, TianFuAn Industrial park,
LeZhuJiao, ZhouShi Road,XiXiang Town, BaoAn
District, ShenZhen City, GuangDong Province , China

PRODUCT SPECIFICATIONS

For Customer: _____

: APPROVAL FOR SPECIFICATION

Customer Model No. _____

: APPROVAL FOR SAMPLE

Module No.: ZW-T070SWH-02P

Date : 2015-01-08

Table of Contents

No.	Item	Page
1	Cover Sheet(Table of Contents)	
2	Revision Record	
3	General Specifications	
4	Outline Drawing	
5	Absolute Maximum Ratings	
6	Electrical Specifications and Instruction Code	
7	Optical Characteristics	
8	Reliability Test Items and Criteria	
9	Precautions for Use of LCD Modules	

For Customer's Acceptance:

Approved By	Comment

PREPARED	CHECKED	VERIFIED BY QA DEPT	VERIFIED BY R&D DEPT
John	Techshu		Dmjiaing

3. General Specifications

ZW-T070SWH-02P is a TFT-LCD module. It is composed of a TFT-LCD panel, driver IC, FPC,TP,a back light unit. The 7.0" display area contains 800 x 480pixels and can display up to 16.7M colors. This product accords with RoHS environmental criterion.

Item	Contents	Unit	Note
LCD Type	TFT	-	
Display color	16.7M		
Viewing Direction	12	O'Clock	
Gray scale inversion direction	6	O'Clock	
Operating temperature	-20~+70	°C	
Storage temperature	-30~+80	°C	
Module size	Refer to outline drawing	mm	
Active Area(W×H)	154.08X85.92	mm	
Number of Dots	800×480	dots	
Controller	HX8264+HX8664	-	
Power Supply Voltage	3.3	V	
Outline Dimensions	Refer to outline drawing	-	
Backlight	3X9-LEDs (white)	pcs	
Weight	---	g	
Interface	RGB888	-	

Note 1: Color tune is slightly changed by temperature and driving voltage.

Note 2: Without FPC and Solder.

5. Absolute Maximum Ratings($T_a=25\text{ }^\circ\text{C}$)

5.1 Electrical Absolute Maximum Ratings.($V_{SS}=0V, T_a=25\text{ }^\circ\text{C}$)

Item	Symbol	Min.	Max.	Unit	Note
Power Supply Voltage	V_{DD}	-0.3	3.6	V	1, 2

Notes:

1. If the module is above these absolute maximum ratings. It may become permanently damaged. Using the module within the following electrical characteristic conditions are also exceeded, the module will malfunction and cause poor reliability.
2. $V_{CC} > V_{SS}$ must be maintained.
3. Please be sure users are grounded when handing LCD Module.

5.2 Environmental Absolute Maximum Ratings.

Item	Storage		Operating		Note
	MIN.	MAX.	MIN.	MAX.	
Ambient Temperature	-30 $^\circ\text{C}$	80 $^\circ\text{C}$	-20 $^\circ\text{C}$	70 $^\circ\text{C}$	1,2
Humidity	-	-	-	-	3

1. The response time will become lower when operated at low temperature.
2. Background color changes slightly depending on ambient temperature.
The phenomenon is reversible.
3. $T_a \leq 40\text{ }^\circ\text{C}$: 85%RH MAX.
 $T_a > 40\text{ }^\circ\text{C}$: Absolute humidity must be lower than the humidity of 85%RH at 40 $^\circ\text{C}$.

6. Electrical Specifications and Instruction Code

6.1 Electrical characteristics ($V_{SS}=0V, T_a=25^\circ C$)

Parameter	Symbol	Condition	Min	Typ	Max	Unit	Note	
Power supply	VDD	$T_a=25^\circ C$	3.0	3.3	3.6	V		
Input voltage	'H'	V_{IH}	$V_{CC}=3.3V$	$0.8V_{DD}$	-	V_{DD}	V	
	'L'	V_{IL}	$V_{CC}=3.3V$	0	-	$0.2V_{DD}$	V	
Current Consumption	I_{DD1}	Normal mode	-	50	-	mA	1	
	I_{DD2}	Sleep mode	-	0.1	-	mA	1	
Clock Frequency	f_{CLK}	-	-	30	50	MHz		

Note:

1: Tested in 1×1 chessboard pattern.

6.2 LED backlight specification ($V_{SS}=0V, T_a=25^\circ C$)

Item	Symbol	Condition	Min	Typ	Max	Unit	Note
Supply voltage	V_f	$I_f=20 \times 9mA$	-	9.0	-	V	
Uniformity	ΔB_p	$I_f=20 \times 9mA$	75			%	
Luminance for LCD(w/o TP)	L_v	$I_f=20 \times 9mA$	-	400		Cd/m ²	

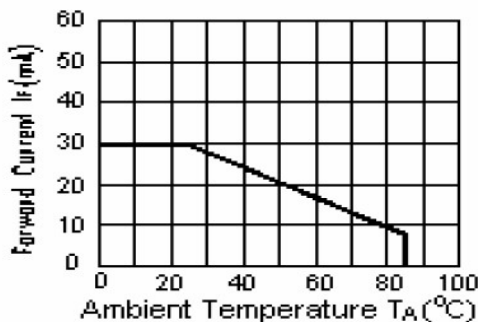

6.3 Interface signals

Pin No.	Symbol	I/O	Function
1	VLED-	P	LED back light(Cathode)
2	VLED+	P	LED back light(Anode)
3	GND	P	Ground.
4	VDD	P	Power supply
5-12	R0~R7	I	Red data bus
13-20	G0~G7	I	Green data bus
21-28	B0~B7	I	Blue data bus
29	GND		Ground.
30	PCLK	I	Data clock
31	DISP	I	Nomal diplay and Standby mode select pin
32	HSYNC	I	Line sync signal
33	VSYNC	I	Frame sync signal
34	DE	I	Data enable pin
35	NC		No connection.
36	GND	P	Ground.
37	XR	O	Touch Panel Control pin
38	YD	O	
39	XL	O	
40	YU	O	

7. Optical Characteristics

Item	Symbol	Condition	Min.	Typ.	Max.	Unit	Note	
Brightness (With TP)	Bp	$\theta=0^\circ$	-	400	-	Cd/m ²	1	
Uniformity	$\triangle Bp$	$\Phi=0^\circ$	75	-	-	%	1,2	
Viewing Angle	3:00	Cr \geq 10	-	65	-	Deg	3	
	6:00		-	55	-			
	9:00		-	65	-			
	12:00		-	65	-			
Contrast Ratio	Cr	$\theta=0^\circ$ $\Phi=0^\circ$	300	500	-	-	4	
Response Time	T _r		-	10	-	ms	5	
	T _f		-	10	-	ms		
Color of CIE Coordinate	W	x	-	0.28	-	-	1,6	
		y	-	0.33	-	-		
	R	x	-	0.51	-	-		
		y	-	0.34	-	-		
	G	x	$\theta=0^\circ$ $\Phi=0^\circ$	-	0.31	-		-
		y		-	0.56	-		-
	B	x		-	0.15	-		-
		y		-	0.14	-		-
NTSC Ratio	S	-		50	60	-	%	

Note: The parameter is slightly changed by temperature, driving voltage and materiel

Note 1: The data are measured after LEDs are turned on for 5 minutes. LCM displays full white. The brightness is the average value of 9 measured spots. Measurement equipment PR-705 (Φ8mm)

Measuring condition:

- Measuring surroundings: Dark room.
- Measuring temperature: Ta=25 °C.
- Adjust operating voltage to get optimum contrast at the center of the display.

Measured value at the center point of LCD panel after more than 5 minutes while backlight

turning on.

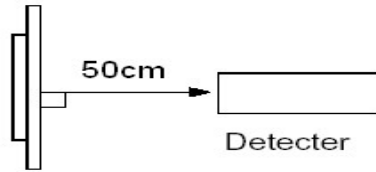

Note 2: The luminance uniformity is calculated by using following formula.

$$\Delta Bp = Bp (\text{Min.}) / Bp (\text{Max.}) \times 100 (\%)$$

$Bp (\text{Max.})$ = Maximum brightness in 9 measured spots

$Bp (\text{Min.})$ = Minimum brightness in 9 measured spots.

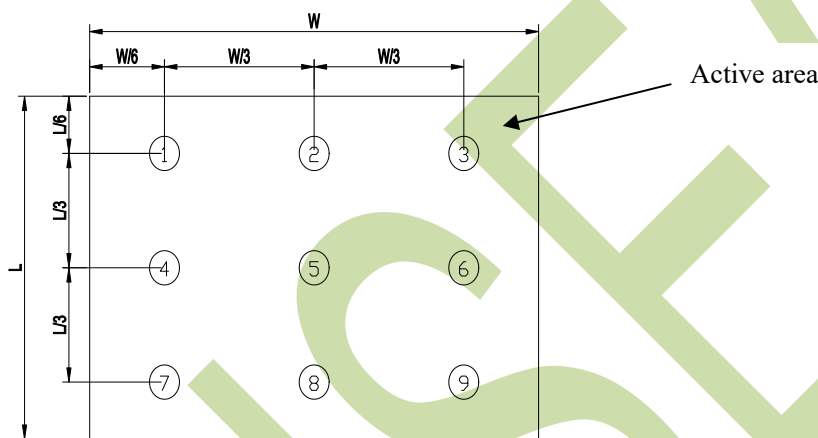

Note 3: The definition of viewing angle:

Refer to the graph below marked by ϑ and ϕ

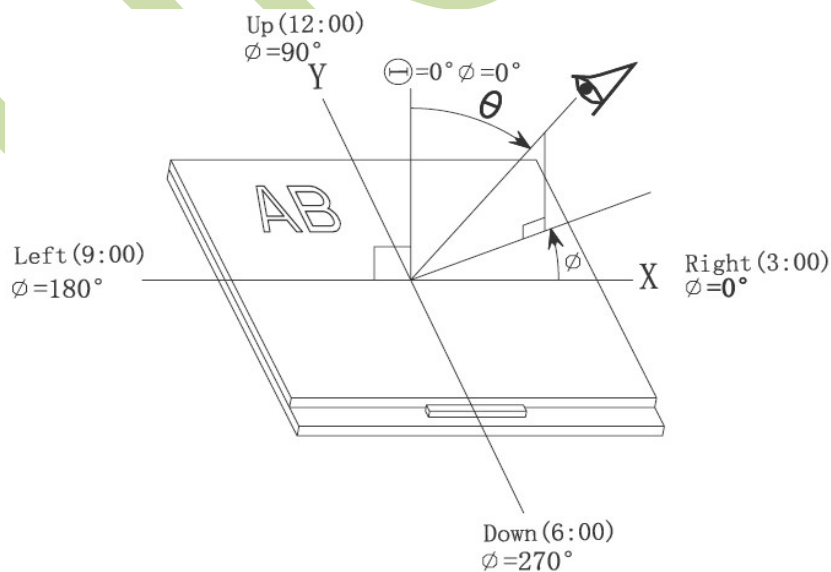

Note 4: Definition of contrast ratio.(Test LCD using DMS501)

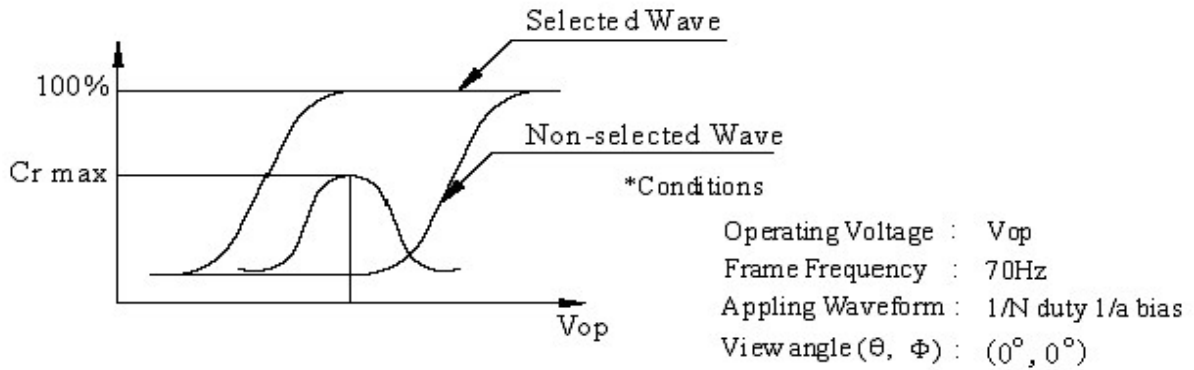

$$\text{Contrast ratio}(Cr) = \frac{\text{Brightness of selected dots}}{\text{Brightness of non-selected dots}}$$

Note 5: Definition of Response time. (Test LCD using DMS501):

The output signals of photo detector are measured when the input signals are changed from "black" to "white"(falling time) and from "white" to "black"(rising time), respectively. The response time is defined as the time interval between the 10% and 90% of amplitudes. Refer to figure as below.

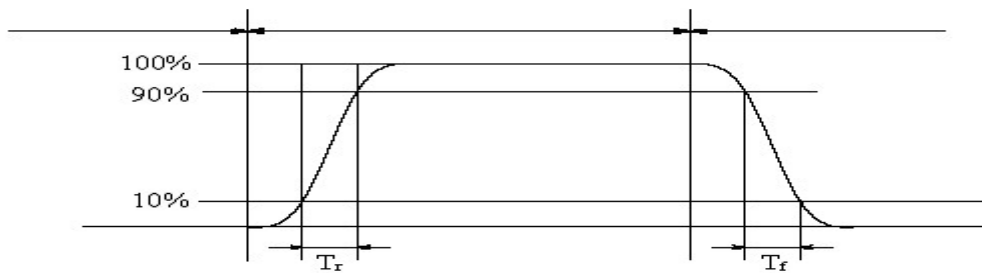

The definition of response time

Note 6: Definition of Color of CIE Coordinate and NTSC Ratio.

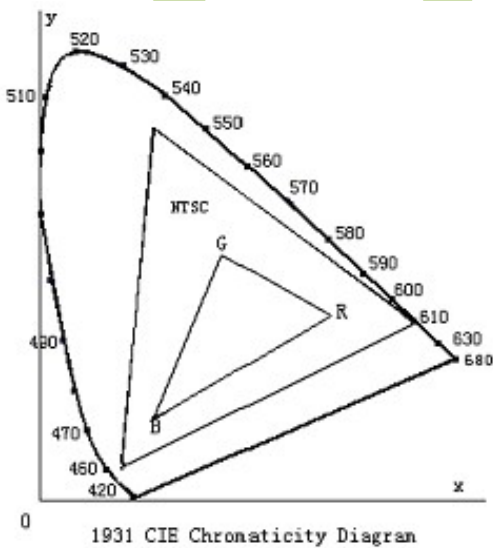

Color gamut:

$$S = \frac{\text{area of RGB triangle}}{\text{area of NTSC triangle}} \times 100\%$$

Note 7: Definition of cross talk.

Cross talk ratio(%)=|pattern A Brightness-pattern B Brightness|/pattern A Brightness*100

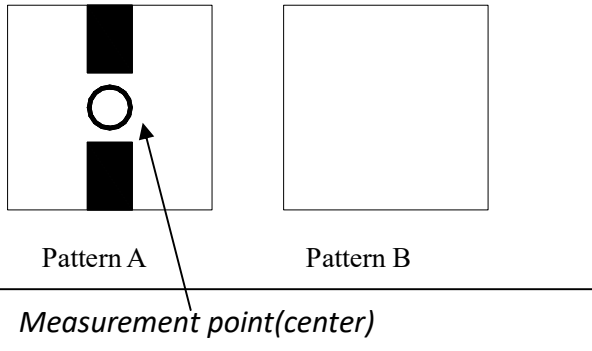

Electric volume value=3F+/-3Hex

DISEA

8. Reliability Test Items and Criteria

No	Test Item	Test condition	Criterion
1	High Temperature Storage	80°C±2°C 96H Restore 2H at 25°C Power off	1. After testing, cosmetic and electrical defects should not happen. 2. Total current consumption should not be more than twice of initial value.
2	Low Temperature Storage	-30°C±2°C 96H Restore 2H at 25°C Power off	
3	High Temperature Operation	70°C±2°C 96H Restore 2H at 25°C Power on	
4	Low Temperature Operation	-20°C±2°C 96H Restore 4H at 25°C Power on	
5	High Temperature/Humidity Operation	60°C±2°C 90%RH 96H Power on	
6	Temperature Cycle	-30°C → 80°C 30min 5min 30min after 5 cycle, Restore 2H at 25°C Power off	
7	Vibration Test	10Hz~150Hz, 100m/s ² , 120min	Not allowed cosmetic and electrical defects.
8	Shock Test	Half- sine wave, 300m/s ² , 11ms	

Note: Operation: Supply 2.8V for logic system.

The inspection terms after reliability test, as below

ITEM	Inspection
Contrast	CR>50%
IDD	IDD<200%
Brightness	Brightness>60%
Color Tone	Color Tone+/-0,05

9. Precautions for Use of LCD Modules

9.1 Handling Precautions

9.1.1 *The display panel is made of glass. Do not subject it to a mechanical shock by dropping it from a high place, etc.*

9.1.2 *If the display panel is damaged and the liquid crystal substance inside it leaks out, be sure not to get any in your mouth, if the substance comes into contact with your skin or clothes, promptly wash it off using soap and water.*

9.1.3 *Do not apply excessive force to the display surface or the adjoining areas since this may cause the color tone to vary.*

9.1.4 *The polarizer covering the display surface of the LCD module is soft and easily scratched. Handle this polarizer carefully.*

9.1.5 *If the display surface is contaminated, breathe on the surface and gently wipe it with a soft dry cloth. If still not completely clear, moisten cloth with one of the following solvents:*

- Isopropyl alcohol*
- Ethyl alcohol*

Solvents other than those mentioned above may damage the polarizer. Especially, do not use the following:

- Water*
- Ketone*
- Aromatic solvents*

9.1.6 *Do not attempt to disassemble the LCD Module.*

9.1.7 *If the logic circuit power is off, do not apply the input signals.*

9.1.8 *To prevent destruction of the elements by static electricity, be careful to maintain an optimum work environment.*

a. Be sure to ground the body when handling the LCD Modules.

b. Tools required for assembly, such as soldering irons, must be properly ground.

c. To reduce the amount of static electricity generated, do not conduct assembly and other work under dry conditions.

d. The LCD Module is coated with a film to protect the display surface. Be care when peeling off this protective film since static electricity may be generated.

9.2 Storage precautions

9.2.1 When storing the LCD modules, avoid exposure to direct sunlight or to the light of fluorescent lamps.

9.2.2 The LCD modules should be stored under the storage temperature range. If the LCD modules will be stored for a long time, the recommend condition is:

Temperature : $0^{\circ}\text{C} \sim 40^{\circ}\text{C}$

Relatively humidity: $\leq 80\%$

9.2.3 The LCD modules should be stored in the room without acid, alkali and harmful gas.

9.3 The LCD modules should be no falling and violent shocking during transportation, and also should avoid excessive press, water, damp and sunshine.

END